



# 25W Multiple-Stage Output Current LED Power Supply **LCM-25DA** series



## ■ Features

- Output current level selectable by DIP S.W.
- 180~277VAC input only
- Built-in active PFC function
- Protections: Short circuit / Over temperature
- Cooling by free air convection
- Fully isolated plastic case
- Class II power unit, no FG
- Built-in DALI interface and push dimming function
- IP20 design
- Logarithm or linear dimming curve selectable (Meet IEC62386-207)
- No load power consumption <0.5W(Note.7)
- Power supplies synchronization function up to 10 units
- 3 years warranty

## ■ Applications

- Indoor LED lighting
- Office LED lighting
- LED decorative lighting

## ■ Description

LCM-25DA is a 25W LED power supply that one single unit supplies multiple current levels, 350mA/ 500mA/600mA/700mA/900mA/1050mA. The current levels are able to be easily switched by adjusting the built-in DIP switch. LCM-25DA also provides the dimming function that is controlled by push dimming or DALI signal. Moreover, the synchronization design allows the dimming for up to 10 units of LCM-25DA to be controlled simultaneously.

## ■ Model Encoding

**LCM - 25 DA**

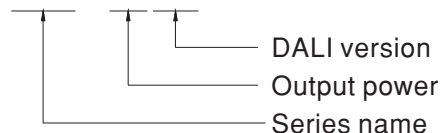



# 25W Multiple-Stage Output Current LED Power Supply **LCM-25DA** series

## SPECIFICATION

MODEL		LCM-25DA					
OUTPUT	SELECTABLE CURRENT <small>Note.3</small>	350mA	500mA	600mA	700mA	900mA	1050mA
	DC VOLTAGE RANGE	6 ~ 54V	6 ~ 50V	6 ~ 42V	6 ~ 36V	6 ~ 28V	6 ~ 24V
	RATED POWER	18.9W	25.2W				
	RIPPLE CURRENT	± 5.0%					
	RIPPLE & NOISE (max.) <small>Note.2</small>	400mVp-p					
	NO LOAD OUTPUT VOLTAGE (max.)	59V			41V		
	CURRENT ACCURACY	± 5.0%					
	SETUP, RISE TIME <small>Note.5</small>	500ms, 50ms / 230VAC at full load					
HOLD UP TIME (Typ.)	30ms / 230VAC at full load						
INPUT	VOLTAGE RANGE <small>Note.4</small>	180 ~ 277VAC	254 ~ 392VDC				
	FREQUENCY RANGE	47 ~ 63Hz					
	POWER FACTOR (Typ.)	PF ≥ 0.94/230VAC, PF ≥ 0.91/277VAC at full load (Please refer to "Power Factor Characteristic" section)					
	TOTAL HARMONIC DISTORTION	THD < 20% when output loading ≥ 50% at 230VAC input and output loading ≥ 75% at 277VAC input					
	EFFICIENCY (Typ.) <small>Note.6</small>	86%					
	AC CURRENT (Typ.)	0.17A/230VAC	0.15A/277VAC				
	INRUSH CURRENT(max.)	COLD START 20A(t <sub>width</sub> =260μs measured at 50% I <sub>peak</sub> ) at 230VAC					
LEAKAGE CURRENT	< 0.5mA / 240VAC						
PROTECTION	SHORT CIRCUIT	Constant current limiting, recovers automatically after fault condition is removed					
	OVER TEMPERATURE	Shut down o/p voltage, recovers automatically after temperature goes down					
FUNCTION	DIMMING	Please refer to "Dimming Operation" section					
	SYNCHRONIZATION	Please refer to "Synchronization Operation" section					
ENVIRONMENT	WORKING TEMP.	-30 ~ +60°C (Please refer to "Derating Curve" section)					
	WORKING HUMIDITY	20 ~ 90% RH non-condensing					
	STORAGE TEMP., HUMIDITY	-40 ~ +80°C, 10 ~ 95% RH					
	TEMP. COEFFICIENT	± 0.03%/°C (0 ~ 50°C)					
	VIBRATION	10 ~ 500Hz, 2G 10min./1cycle, period for 60min. each along X, Y, Z axes					
SAFETY & EMC	SAFETY STANDARDS	UL8750, CSA C22.2 NO.250.0-08, ENEC EN61347-1, EN61347-2-13, EN62384 independent approved					
	DALI STANDARDS	Comply with IEC62386-101,102,207					
	WITHSTAND VOLTAGE	I/P-O/P:3.75KVAC ; I/P-DA ±:1.875KVAC ; O/P-DA ±:1.875KVAC					
	ISOLATION RESISTANCE	I/P-O/P:>100M Ohms / 500VDC / 25°C / 70% RH					
	EMC EMISSION	Compliance to EN55015, EN61000-3-2 Class C(≥ 50% load) ; EN61000-3-3					
OTHERS	EMC IMMUNITY	Compliance to EN61000-4-2,3,4,5,6,8,11, EN55024, EN61547 light industry level (surge 2KV), criteria A					
	MTBF	213.3K hrs min.	MIL-HDBK-217F (25°C)				
	DIMENSION	105*68*23mm (L*W*H)					
	PACKING	0.17Kg ; 72pcs/13.2Kg/1.04CUFT					
NOTE	<ol style="list-style-type: none"> <li>All parameters NOT specially mentioned are measured at 230VAC input, rated load and 25°C of ambient temperature.</li> <li>Ripple &amp; noise are measured at 20MHz of bandwidth by using a 12" twisted pair-wire terminated with a 0.1uf &amp; 47uf parallel capacitor.</li> <li>Please refer to "DIP Switch Table" section.</li> <li>Derating may be needed under low input voltage. Please check the static characteristics for more details.</li> <li>Length of set up time is measured at first cold start. Turning ON/OFF the power supply may lead to increase of the set up time.</li> <li>Efficiency is measured at 500mA/50V output set by DIP switch.</li> <li>No load power consumption&lt;0.5W is measured at 230VAC, with lighting fixture connected and output current dimmed to 0%.</li> <li>The power supply is considered as a component that will be operated in combination with final equipment. Since EMC performance will be affected by the complete installation, the final equipment manufacturers must re-qualify EMC Directive on the complete installation again.</li> </ol>						

## ■ Block Diagram

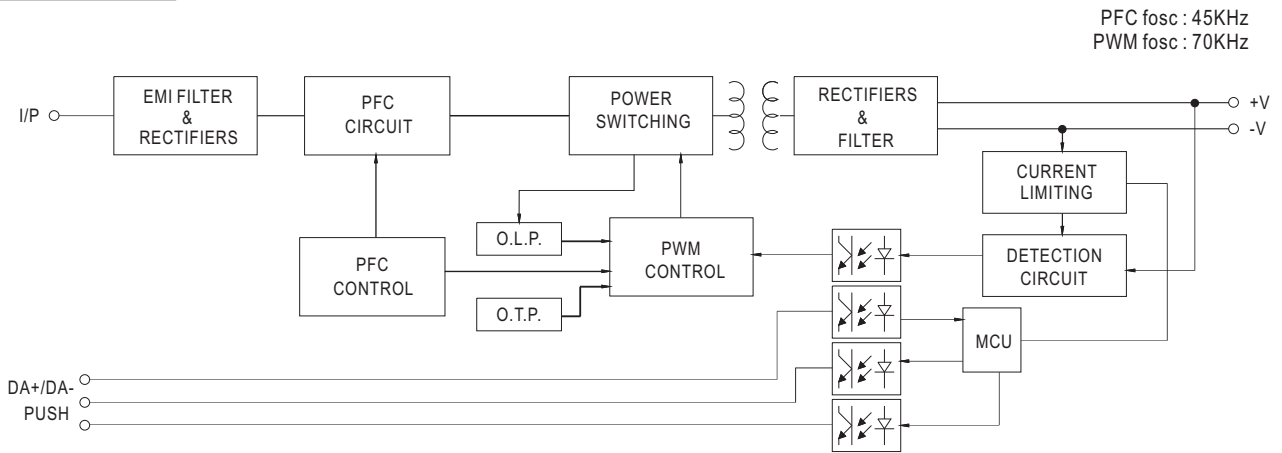

## ■ Derating Curve

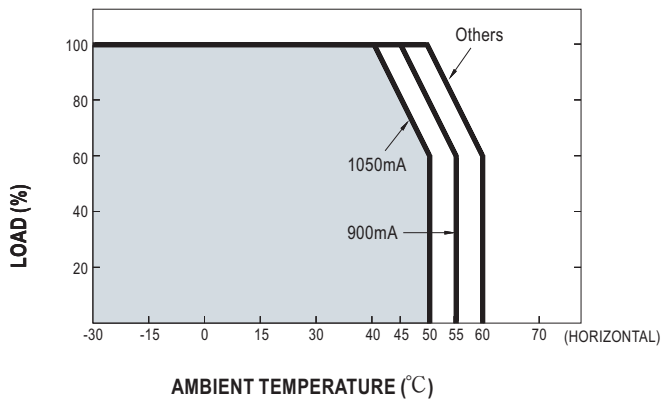

## ■ Static Characteristics

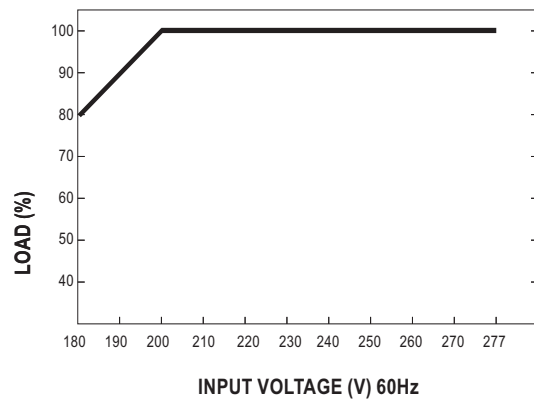

## ■ DIP Switch Table

LCM-25DA is a multiple-stage output current supply, selection of output current through DIP switch as table below.

Io	DIP S.W.	1	2	3	4	5	6
350mA		----	----	----	----	----	----
500mA		ON	----	----	----	----	----
600mA		ON	ON	----	----	----	----
700mA(Factory Setting)		ON	ON	ON	----	----	ON
900mA		ON	ON	ON	ON	----	ON
1050mA		ON	ON	ON	ON	ON	ON

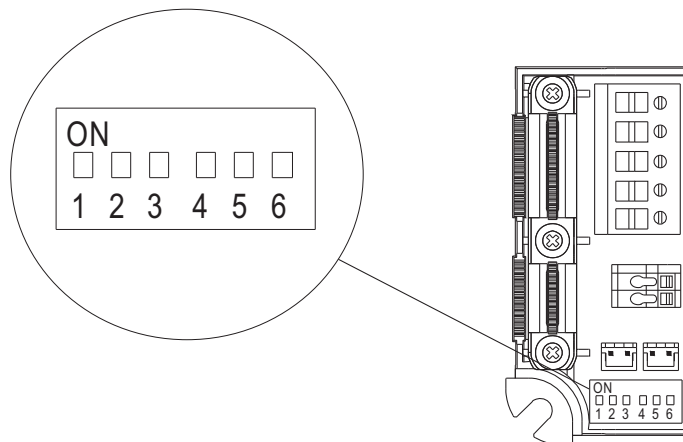

### Power Factor Characteristic

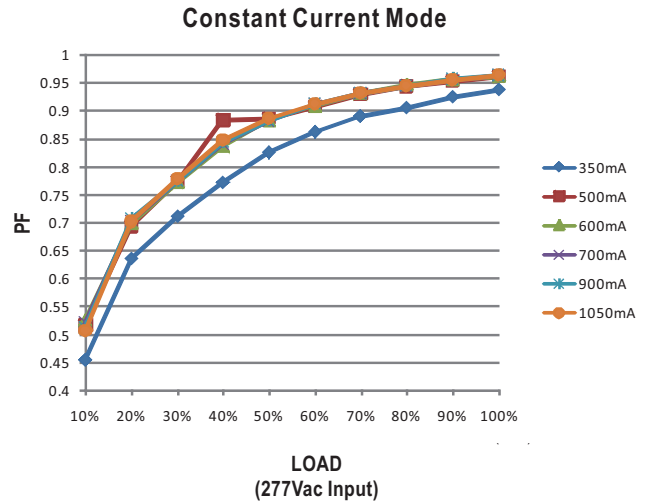
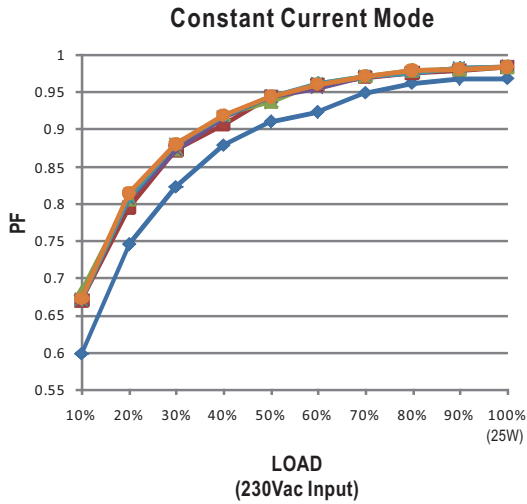

### Total Harmonic Distortion Characteristic

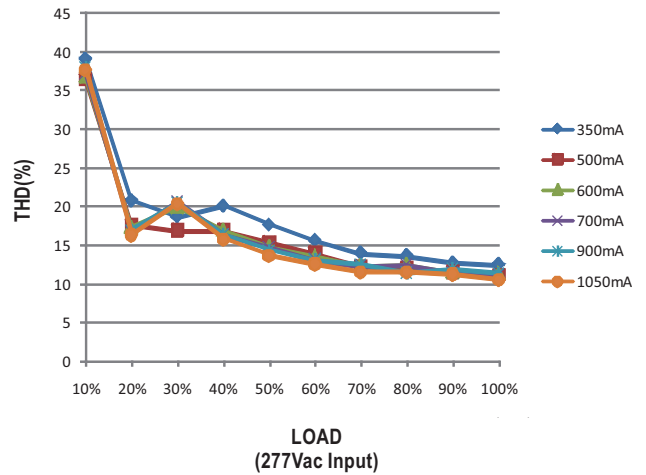
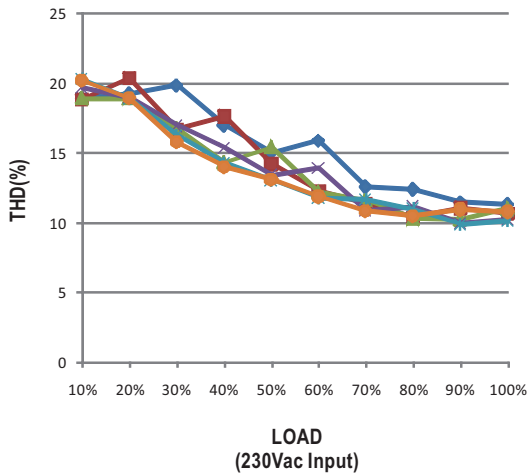

### Efficiency vs Load

LCM-25DA possess superior working efficiency that up to 86% can be reached in field applications.

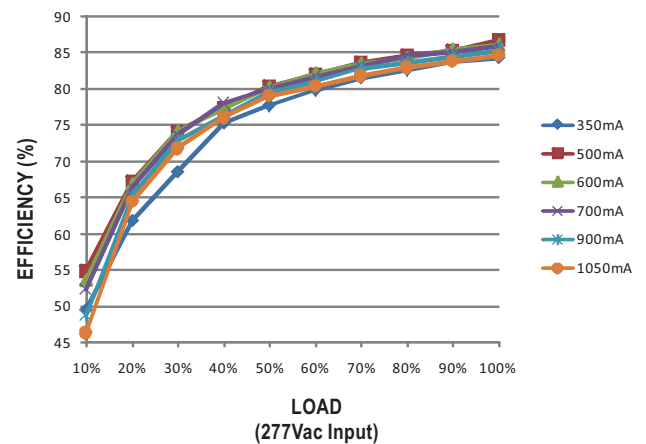
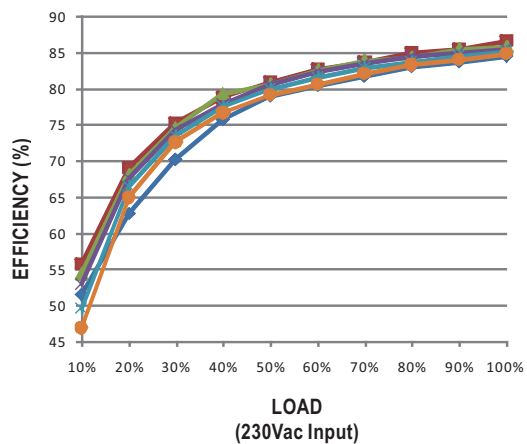

## ■ Dimming Operation

### ※ PUSH dim(primary side)

Ignore	To avoid reaction on AC spike	<0.05 sec.
Short push	Push to turn ON-OFF	0.1~1 sec.
Long push	Dimming up or down	1.5~10 sec.
Reset push	Setting light to 100%	>11 sec.

- Maximum number of drivers up to 10 pcs.
- Maximum length of the cable, from push button to the last driver is 135 meters.
- Factory setting at 100%.
- Every long pushing action will change the dimming direction.

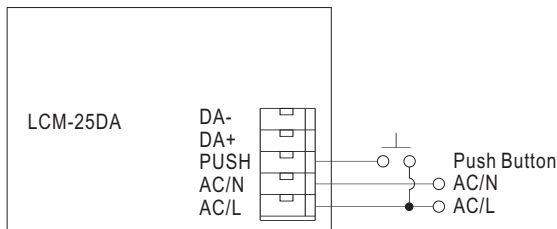

Warning: The push button can only be connected in between the PUSH terminal of LCM-25DA and AC/L (brown or black color). It would cause short circuit if it is connected to AC/N.

### ※ DALI interface(primary side)

- DALI protocol including 16 groups and 64 addresses.
- First step is fixed at 6% of output.
- Maximum DALI cable length is 300 meters.(based on a 1.5 mm<sup>2</sup> or 14 AWG cable)

## ■ Synchronization Operation

- 10 drivers(max.) synchronization (1 master + 9 slaves).
- Maximum cable length between each units : 20 meters.
- Maximum cable length from the master unit to each end of the last slave units : 120 meters.
- ※ Please make sure all units are set to 100% dimming setting (factory default) before synchronization.
- The lighting units driven by LCM units(Slaves) can be dimmed synchronously through a LCM unit(the master) directly controlled via DALI or push dim dimming function. The wiring is shown as follows.

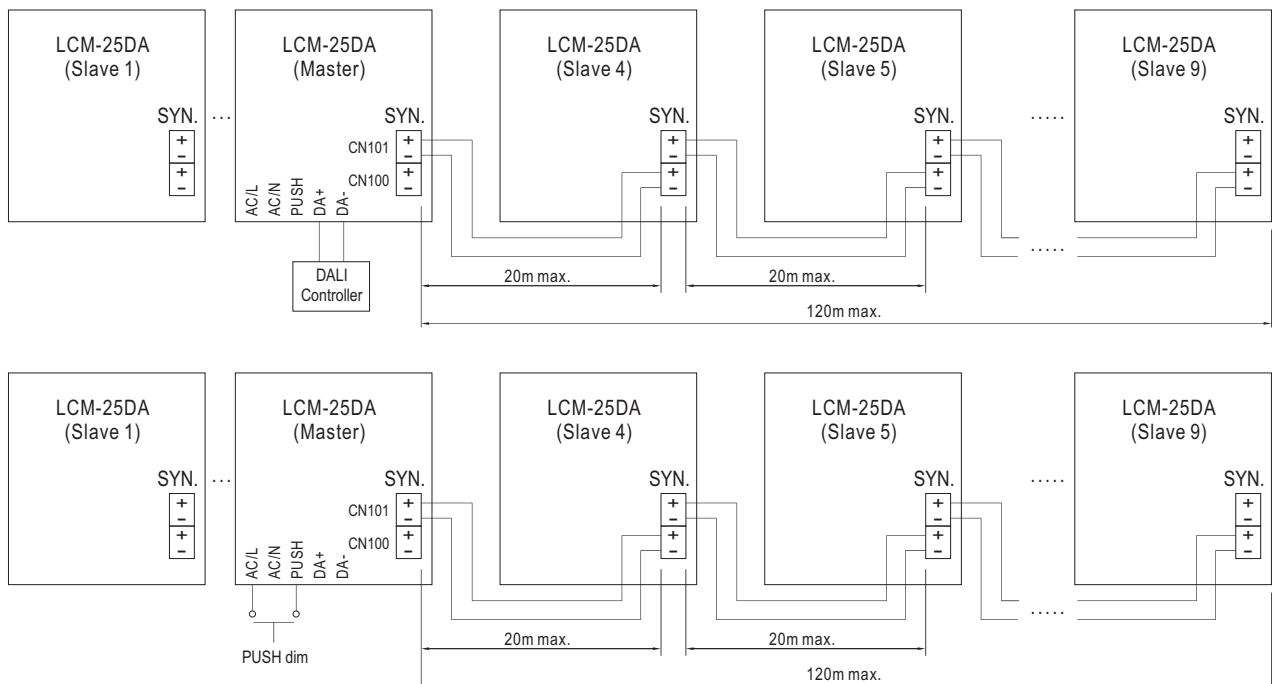

- CN100, CN101 : used to synchronously control the LCM units in parallel.

## Mechanical Specification

Case No. LCM-25 Unit:mm

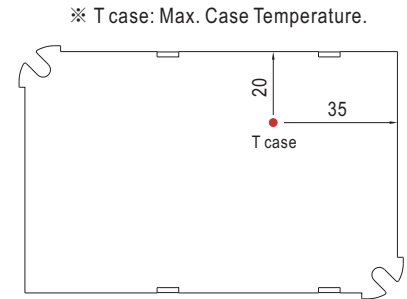
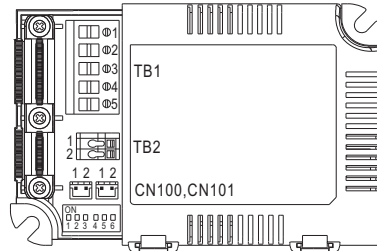
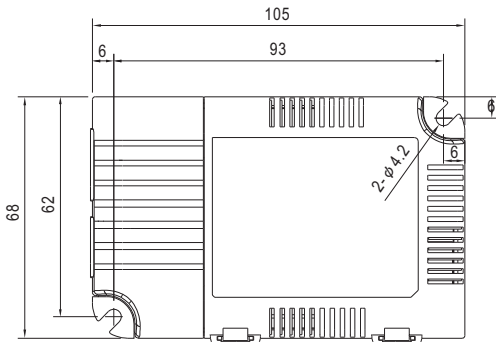

Bottom View

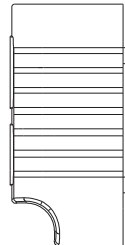
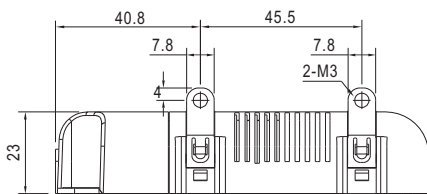

### Terminal Pin No. Assignment(TB2)

Pin No.	Assignment
1	+Vo
2	-Vo

### SYN. Connector(CN100/CN101):JST B2B-PH-KL or equivalent

Pin No.	Assignment	Mating Housing	Terminal
1	-	JST PHR-2 or equivalent	JST SPH-002T-P0.5S or equivalent
2	+		

### Terminal Pin No. Assignment(TB1)

Pin No.	Assignment	Pin No.	Assignment
1	AC/L	4	DA+
2	AC/N	5	DA-
3	PUSH		

Note:Please use wires with a cross section of 0.5~2.5mm<sup>2</sup>(14~20AWG) for TB1 and wires with a cross section of 0.5~1.5 mm<sup>2</sup>(16~20AWG) for TB2.  
Please use wires with a cross section of 0.126~0.205mm<sup>2</sup>(24~26AWG) for CN100/CN101

## Installation Manual

Please refer to : <http://www.meanwell.com/webnet/search/InstallationSearch.html>