

NICHIA CORPORATION

SPECIFICATIONS FOR WHITE LED

NFCWL060B-V2

- Built-in ESD Protection Device
- RoHS Compliant

SPECIFICATIONS

(1) Absolute Maximum Ratings

Item	Symbol	Absolute Maximum Rating	Unit
Forward Current	I_F	900	mA
Pulse Forward Current	I_{FP}	1350	mA
Allowable Reverse Current	I_R	85	mA
Power Dissipation	P_D	32.8	W
Operating Temperature	T_{opr}	-40~105	°C
Storage Temperature	T_{sta}	-40~100	°C
Junction Temperature	T_J	140	°C

* Absolute Maximum Ratings at $T_J=25^{\circ}\text{C}$.

* I_{FP} conditions with pulse width $\leq 10\text{ms}$ and duty cycle $\leq 10\%$.

* For I_F and I_{FP} , see the "DERATING CHARACTERISTICS" of this specification.

* The operating Temperature (T_{opr}) range is the range of case temperatures.

(2) Initial Electrical/Optical Characteristics

Item		Symbol	Condition	Typ	Max	Unit
Forward Voltage		V_F	$I_F=460\text{mA}$	34.9	-	V
R70	Luminous Flux (Chromaticity Coordinate1)	Φ_v	$I_F=460\text{mA}$	2780	-	lm
	Color Rendering Index (Chromaticity Coordinate1)	R_a	$I_F=460\text{mA}$	73	-	-
R8000	Luminous Flux (Chromaticity Coordinate1)	Φ_v	$I_F=460\text{mA}$	2610	-	lm
	Color Rendering Index (Chromaticity Coordinate1)	R_a	$I_F=460\text{mA}$	83	-	-
R9050	Luminous Flux (Chromaticity Coordinate1)	Φ_v	$I_F=460\text{mA}$	2240	-	lm
	Color Rendering Index (Chromaticity Coordinate1)	R_a	$I_F=460\text{mA}$	93	-	-
R95	Luminous Flux (Chromaticity Coordinate1)	Φ_v	$I_F=460\text{mA}$	1830	-	lm
	Color Rendering Index (Chromaticity Coordinate1)	R_a	$I_F=460\text{mA}$	98	-	-
Chromaticity Coordinate1	x	-	$I_F=460\text{mA}$	0.4338	-	-
	y	-	$I_F=460\text{mA}$	0.4030	-	-
R70	Luminous Flux (Chromaticity Coordinate2)	Φ_v	$I_F=460\text{mA}$	2910	-	lm
	Color Rendering Index (Chromaticity Coordinate2)	R_a	$I_F=460\text{mA}$	73	-	-
R8000	Luminous Flux (Chromaticity Coordinate2)	Φ_v	$I_F=460\text{mA}$	2760	-	lm
	Color Rendering Index (Chromaticity Coordinate2)	R_a	$I_F=460\text{mA}$	83	-	-
R9050	Luminous Flux (Chromaticity Coordinate2)	Φ_v	$I_F=460\text{mA}$	2420	-	lm
	Color Rendering Index (Chromaticity Coordinate2)	R_a	$I_F=460\text{mA}$	93	-	-
R95	Luminous Flux (Chromaticity Coordinate2)	Φ_v	$I_F=460\text{mA}$	2080	-	lm
	Color Rendering Index (Chromaticity Coordinate2)	R_a	$I_F=460\text{mA}$	98	-	-
Chromaticity Coordinate2	x	-	$I_F=460\text{mA}$	0.3447	-	-
	y	-	$I_F=460\text{mA}$	0.3553	-	-
Thermal Resistance		$R_{\theta JC}$	-	1.4	1.7	$^{\circ}\text{C}/\text{W}$

* Characteristics at $T_j=25^{\circ}\text{C}$ and measured in pulse mode.

* Optical Characteristics as per CIE 127:2007 standard.

* Chromaticity Coordinates as per CIE 1931 Chromaticity Chart.

* $R_{\theta JC}$ is measured using the Dynamic Mode detailed in JESD51-1.

* $R_{\theta JC}$ is the thermal resistance from the junction to the T_C measurement point.

RANKS

Item	Rank	Condition	Min	Max	Unit
Forward Voltage	-	I _F =460mA	33.7	36.5	V
Luminous Flux	Q0261	I _F =460mA	2610	3190	lm
	Q0257		2570	3150	
	Q0252		2520	3080	
	Q0250		2500	3060	
	Q0248		2480	3040	
	Q0247		2470	3030	
	Q0245		2450	3010	
	Q0244		2440	3000	
	Q0242		2420	2960	
	Q0234		2340	2880	
	Q0227		2270	2790	
	Q0220		2200	2700	
	Q0217		2170	2670	
	Q0215		2150	2630	
	Q0209		2090	2570	
	Q0203		2030	2490	
	Q0201		2010	2470	
	Q0194		1940	2380	
	Q0190		1900	2340	
	Q0187		1870	2290	
	Q0183		1830	2250	
	Q0180		1800	2220	
	Q0179		1790	2190	
Q0174	1740	2140			
Q0164	1640	2020			
Q0162	1620	1980			
Q0153	1530	1890			
Color Rendering Index	R70	R _a	70	-	-
	R8000	R _a	80	-	-
		R ₉	0	-	-
	R9050	R _a	90	-	-
		R ₉	50	-	-
R95	R _a	95	-	-	

Color Ranks(I_F=460mA)

		Rank sm223	Rank sm253	Rank sm273	Rank sm303	Rank sm353	Rank sm403
Color Temperature (Unit: K)	T _{CP}	2200	2500	2700	3000	3500	4000
Center Point	x	0.5018	0.4806	0.4578	0.4338	0.4073	0.3818
	y	0.4153	0.4141	0.4101	0.4030	0.3917	0.3797

		Rank sm453	Rank sm503	Rank sm573	Rank sm653
Color Temperature (Unit: K)	T _{CP}	4500	5000	5700	6500
Center Point	x	0.3611	0.3447	0.3287	0.3123
	y	0.3658	0.3553	0.3417	0.3282

- * Ranking at T_J=25°C and measured in pulse mode.
 - * Forward Voltage Tolerance: ±0.35V
 - * Luminous Flux Tolerance: ±5%
 - * Color Rendering Index R_a Tolerance: ±2
 - * Color Rendering Index R₉ Tolerance: ±6.5
 - * The R₉ value for the above rank shall be greater than 0.
 - * Chromaticity Coordinate Tolerance: ±0.005
 - * The color rank has a chromaticity range within a 3-step MacAdam ellipse.
 - * LEDs from the above ranks will be shipped.
- The rank combination ratio per shipment will be decided by Nichia.

Luminous Flux Ranks by Color Rank, Color Rendering Index Rank

Color Coordinates	Color Rendering Index	Luminous Flux
sm223	R8000	Q0203
	R9050	Q0162
sm253	R8000	Q0215
	R9050	Q0179
sm273	R70	Q0244
	R8000	Q0227
	R9050	Q0194
	R95	Q0153
sm303	R70	Q0250
	R8000	Q0234
	R9050	Q0201
	R95	Q0164
sm353	R70	Q0257
	R8000	Q0242
	R9050	Q0209
	R95	Q0174
sm403	R70	Q0261
	R8000	Q0247
	R9050	Q0215
	R95	Q0180
sm453	R70	Q0261
	R8000	Q0252
	R9050	Q0220
	R95	Q0183
sm503	R70	Q0261
	R8000	Q0248
	R9050	Q0217
	R95	Q0187
sm573	R70	Q0257
	R8000	Q0248
	R9050	Q0220
	R95	Q0190
sm653	R70	Q0257
	R8000	Q0245
	R9050	Q0220
	R95	Q0194

CHROMATICITY DIAGRAM

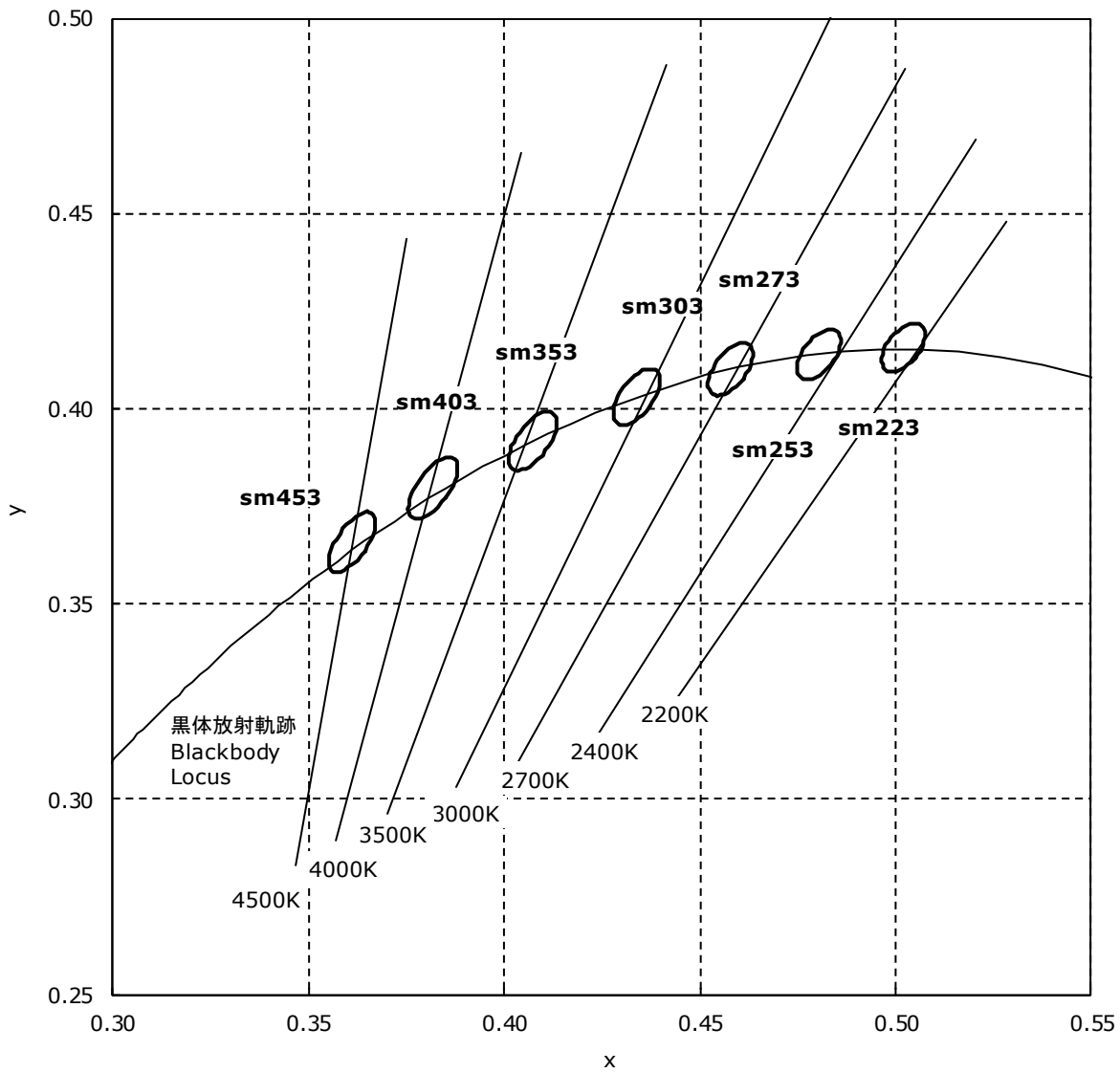

CHROMATICITY DIAGRAM

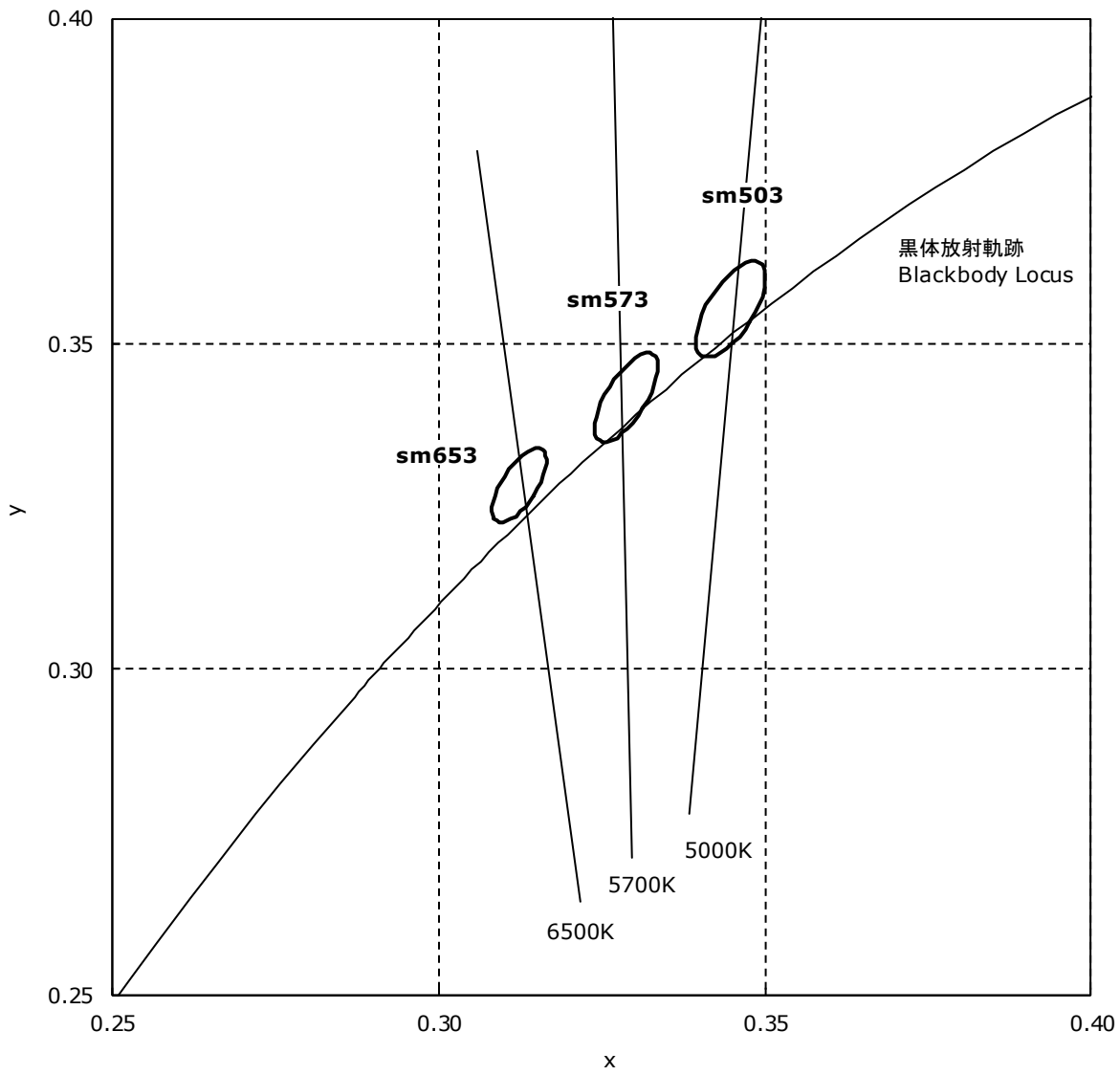

OUTLINE DIMENSIONS

* 本製品はRoHS指令に適合しております。
This product complies with RoHS Directive.

NFCWL060B-V2
管理番号 No. STS-DA7-10874

* 括弧で囲まれた寸法は参考値です。
The dimension(s) in parentheses are for reference purposes.

(単位 Unit: mm, 公差 Tolerance: ±0.3)

光学的中心位置
Location of the optical center
発光部中心の位置精度 ±0.3mm
The center of emitting area to be centered ±0.3mm.

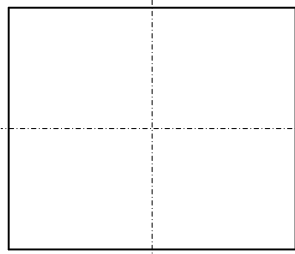
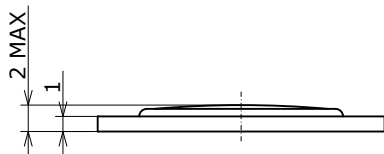
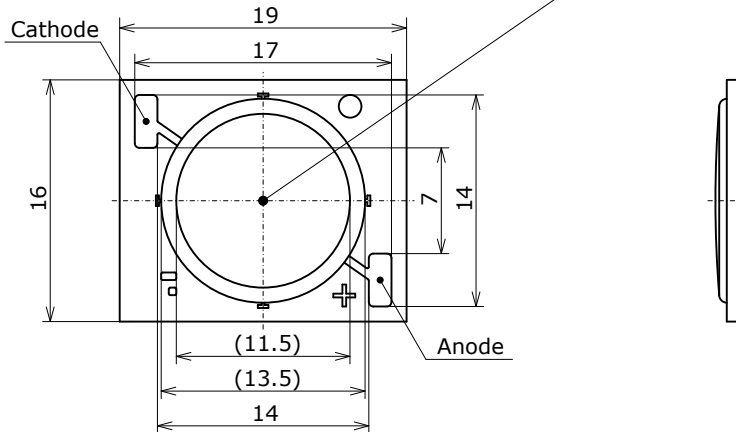

項目 Item	内容 Description
パッケージ材質 Package Materials	セラミックス Ceramics
封止樹脂材質 Encapsulating Resin Materials	シリコン樹脂 (拡散剤+蛍光体入り) Silicone Resin (with diffuser and phosphor)
電極材質 Electrodes Materials	金メッキ Au-plated
質量 Weight	1.2g(TYP)

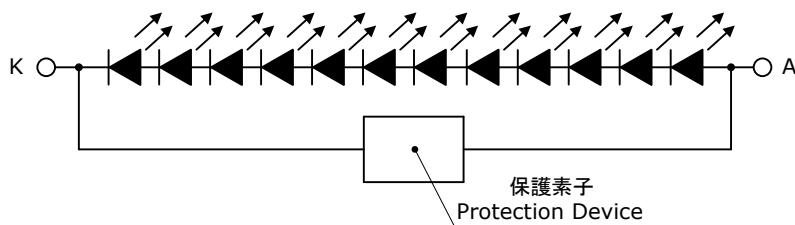

SOLDERING

- Recommended Hand Soldering Condition

Temperature	380°C Max
Soldering Time	5sec Max

- * Hand soldering must not be performed more than once.
- * Since the silicone used in the encapsulating resin frame is soft, do not press on the encapsulating resin frame or resin area. Pressure can cause nicks, chip-outs, encapsulant delamination and deformation, and wire breaks, decreasing reliability.
- * Repairing should not be done after the LEDs have been soldered.
It should be confirmed beforehand whether the characteristics of the LEDs will or will not be damaged by repairing.
- * When soldering, do not apply stress to the LED while the LED is hot.
- * When using a pick and place machine, choose an appropriate nozzle for this product. Using a pick-and-place nozzle with a smaller diameter than the size of the LED's emitting surface will cause damage to the emitting surface and may also cause the LED not to illuminate.
- * When flux is used, it should be a halogen free flux. Ensure that the manufacturing process is not designed in a manner where the flux will come in contact with the LEDs.
- * During and/or after soldering an electric wire to the electrode, ensure that tension is not applied to the electric wire. This may cause the electrode to be damaged and/or reduce the adhesive strength of the electrode to the package.
- * If soldering is used to join electric wires to the electrodes, the adhesive strength of the electrode to the package may be reduced depending on the substances that are found in the solder paste and/or the type of the wire cover that is used. Ensure that there are no issues with the materials that will be used in the chosen application prior to use.

TRAY DIMENSIONS

* 数量は1トレイにつき 54個入りです。
 Tray Size: 54pcs

NxxxL060x
 管理番号 No. STS-DA7-5899

* 寸法は参考です。
 All dimensions shown are for reference only and are not guaranteed.

(単位 Unit: mm)

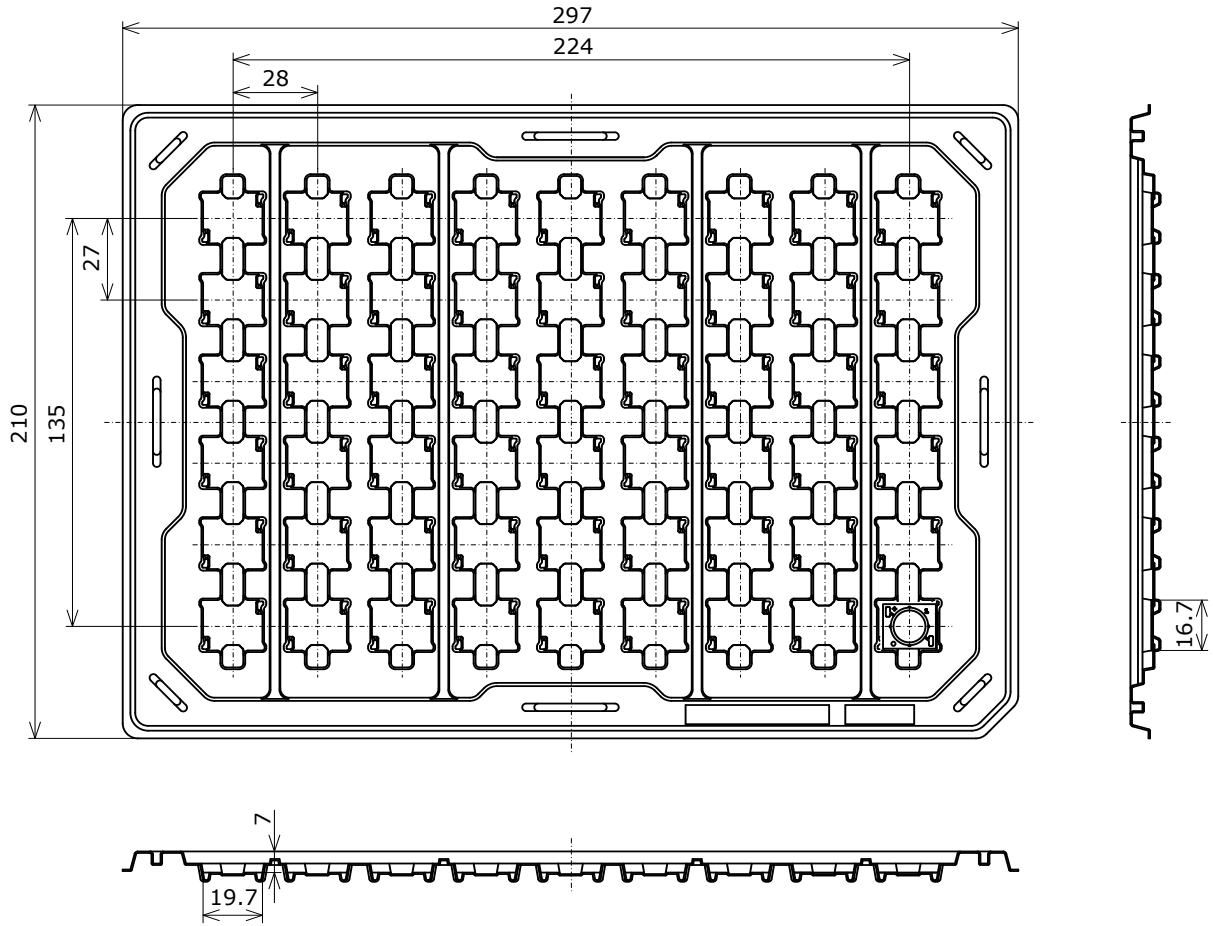

PACKAGING - TRAY PACK

シリカゲルとともにトレイをアルミ防湿袋に入れ、熱シールにより封をします。
Trays are shipped with desiccants in heat-sealed moisture-proof bags.

Nxxxxxxx
管理番号 No. STS-DA7-5106

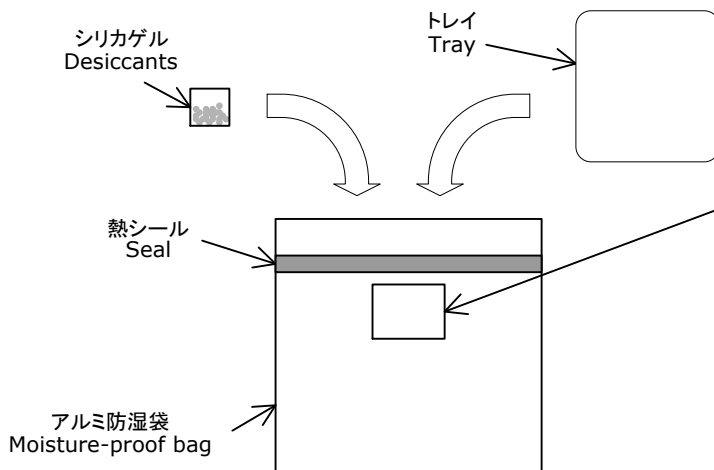

ラベル Label

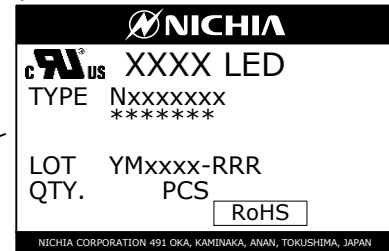

アルミ防湿袋を並べて入れ、ダンボールで仕切ります。
Moisture-proof bags are packed in cardboard boxes with corrugated partitions.

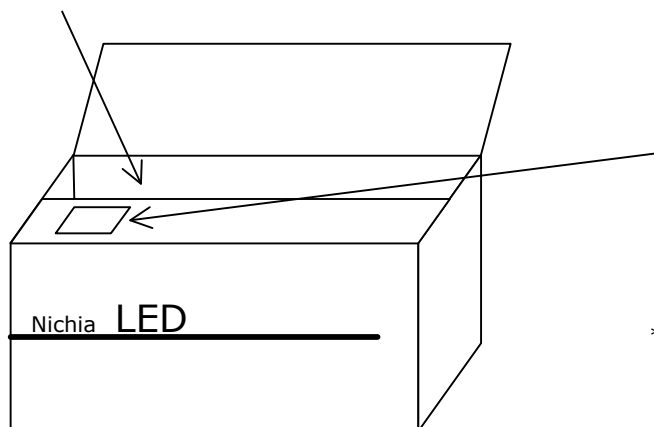

ラベル Label



- * 客先型名を*****で示します。
客先型名が設定されていない場合は空白です。
***** is the customer part number.
If not provided, it will not be indicated on the label.
- * ロット表記方法についてはロット番号の項を参照して下さい。
For details, see "LOT NUMBERING CODE" in this document.

- * 本製品はトレイに入れたのち、輸送の衝撃から保護するためダンボールで梱包します。
Products shipped on trays are packed in a moisture-proof bag.
They are shipped in cardboard boxes to protect them from external forces during transportation.
- * 取り扱いに際して、落下させたり、強い衝撃を与えたりしますと、製品を損傷させる原因になりますので注意して下さい。
Do not drop or expose the box to external forces as it may damage the products.
- * ダンボールには防水加工がされておりませんので、梱包箱が水に濡れないよう注意して下さい。
Do not expose to water. The box is not water-resistant.
- * 輸送、運搬に際して弊社よりの梱包状態あるいは同等の梱包を行って下さい。
Using the original package material or equivalent in transit is recommended.

LOT NUMBERING CODE

Lot Number is presented by using the following alphanumeric code.

YMxxxx - RRR

Y - Year

Year	Y
2015	F
2016	G
2017	H
2018	I
2019	J
2020	K

M - Month

Month	M	Month	M
1	1	7	7
2	2	8	8
3	3	9	9
4	4	10	A
5	5	11	B
6	6	12	C

xxxx-Nichia's Product Number

RRR-Ranking by Color Coordinates, Ranking by Luminous Flux, Ranking by Color Rendering Index

DERATING CHARACTERISTICS

NFCWL060B-V2
 管理番号 No. STS-DA7-10875A

ケース温度測定部温度-許容順電流特性
 Temperature at Measure Point on a Case vs
 Allowable Forward Current

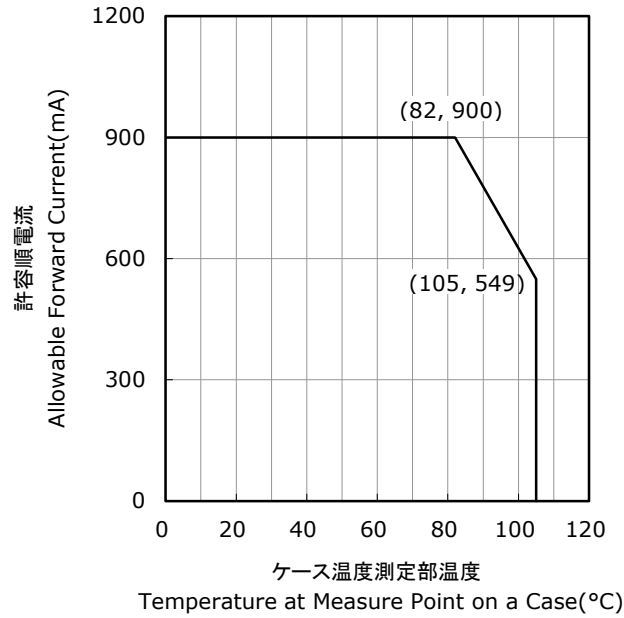

デューティー比-許容順電流特性
 Duty Ratio vs
 Allowable Forward Current

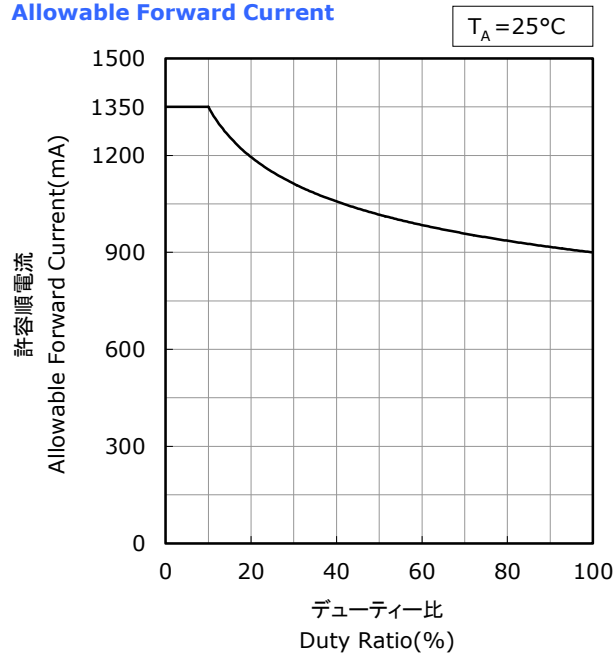

OPTICAL CHARACTERISTICS

- * 本特性は参考です。
All characteristics shown are for reference only and are not guaranteed.
- * パルス駆動により測定しています。
The following graphs show characteristics in pulse mode.

NFCWL060B-V2
管理番号 No. STS-DA7-10794

発光スペクトル Spectrum

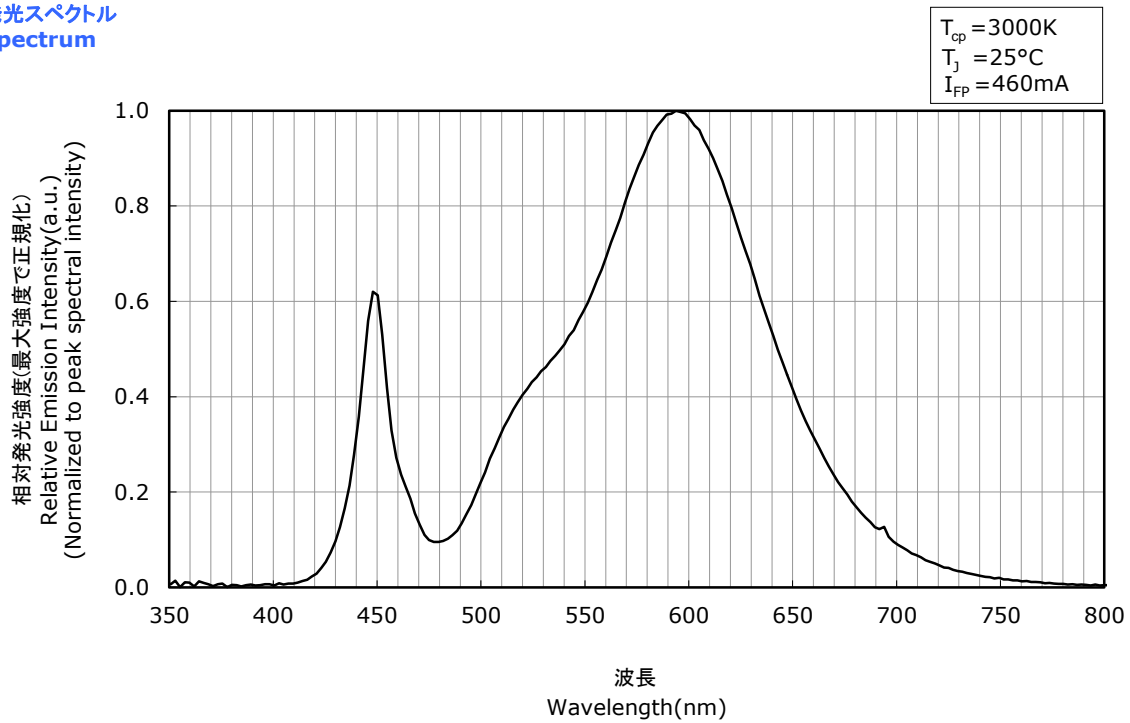

指向特性 Directivity

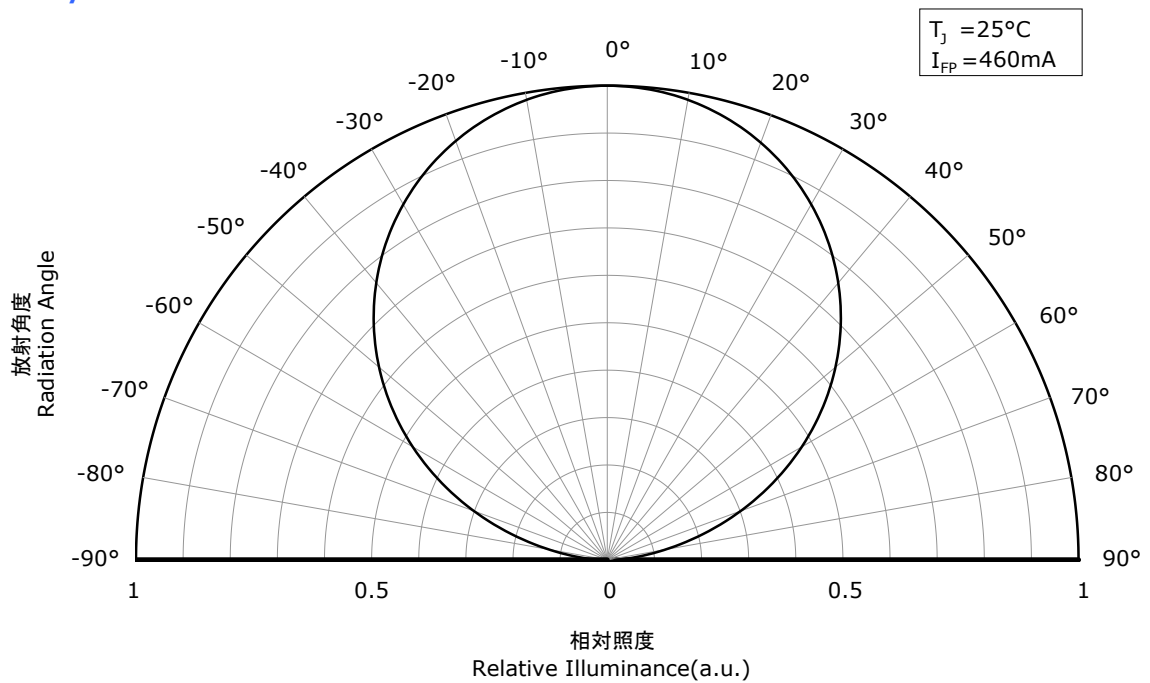

- * 本特性は演色性ランクR70に対応しています。
The graphs above show the characteristics for R70 LEDs of this product.

OPTICAL CHARACTERISTICS

- * 本特性は参考です。
All characteristics shown are for reference only and are not guaranteed.
- * パルス駆動により測定しています。
The following graphs show characteristics in pulse mode.

NFCWL060B-V2
管理番号 No. STS-DA7-10795

発光スペクトル Spectrum

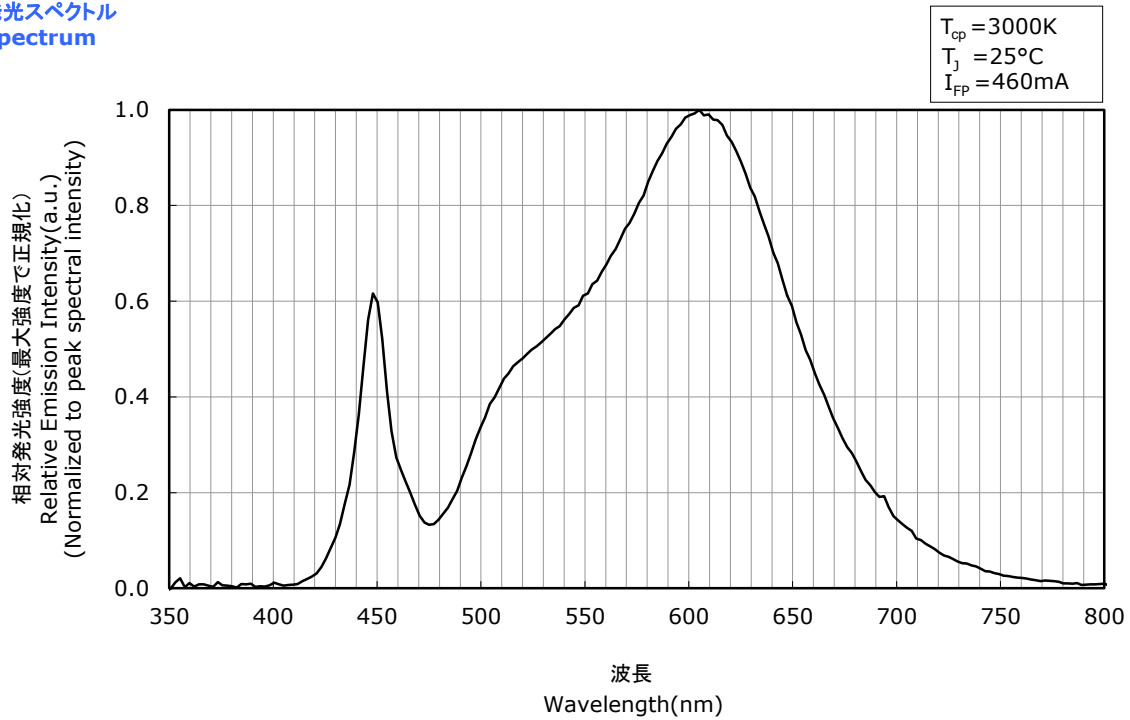

指向特性 Directivity

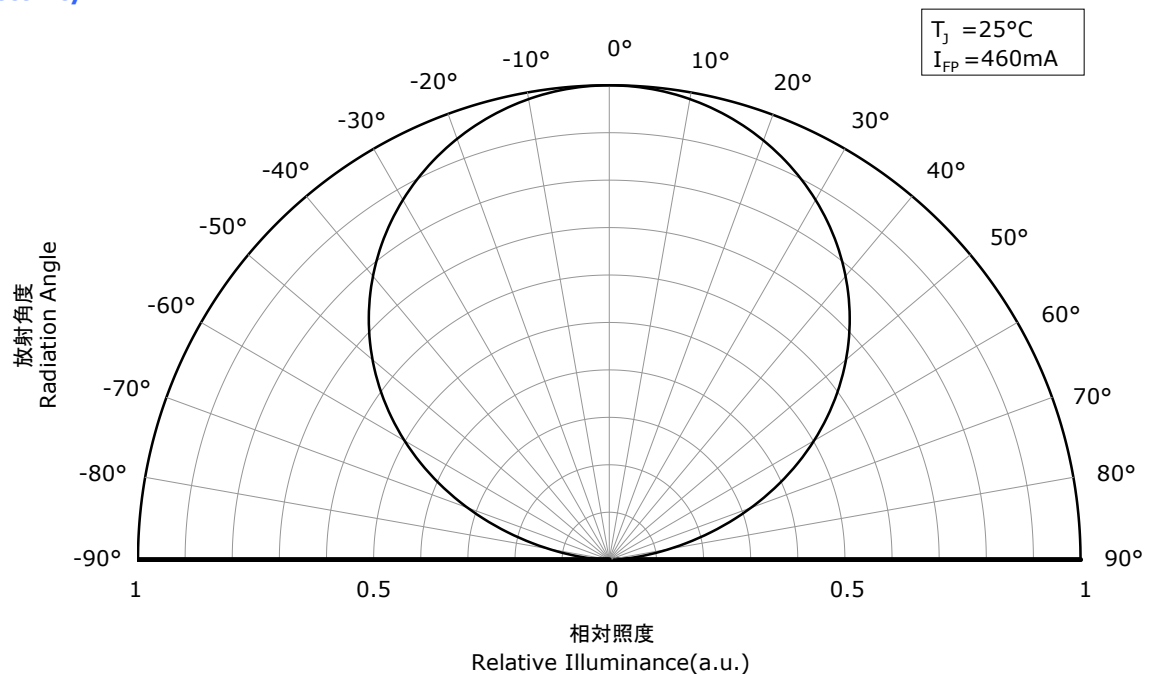

- * 本特性は演色性ランクR8000に対応しています。
The graphs above show the characteristics for R8000 LEDs of this product.

OPTICAL CHARACTERISTICS

- * 本特性は参考です。
All characteristics shown are for reference only and are not guaranteed.
- * パルス駆動により測定しています。
The following graphs show characteristics in pulse mode.

NFCWL060B-V2
管理番号 No. STS-DA7-10796

発光スペクトル Spectrum

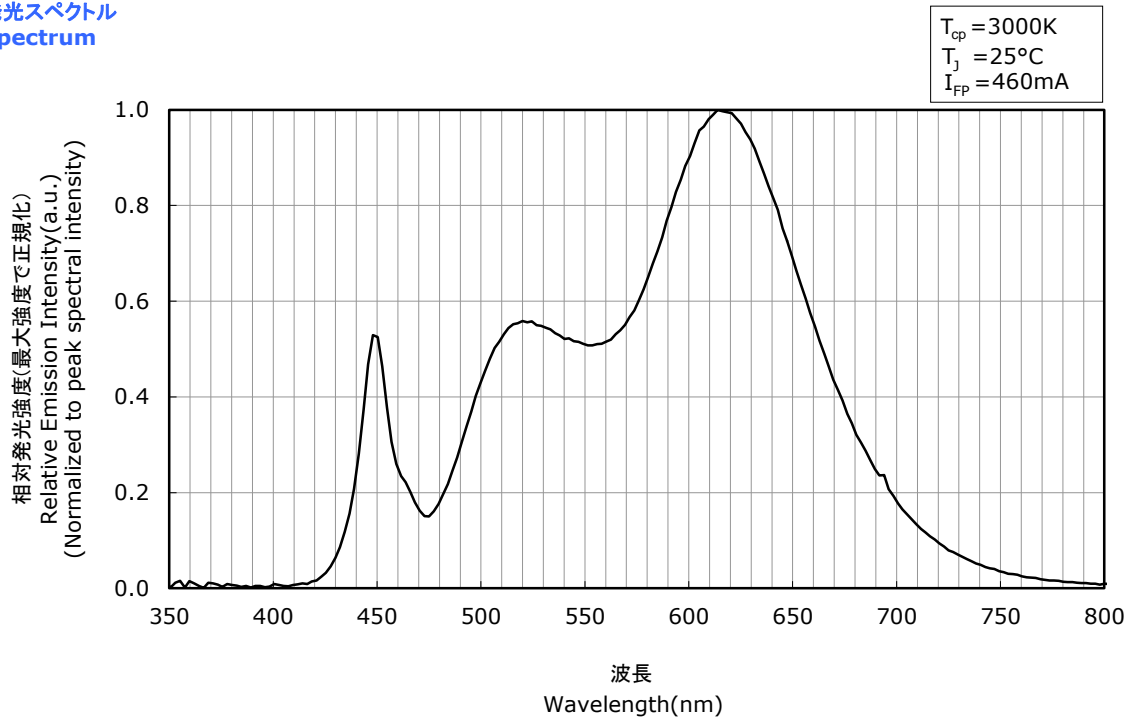

指向特性 Directivity

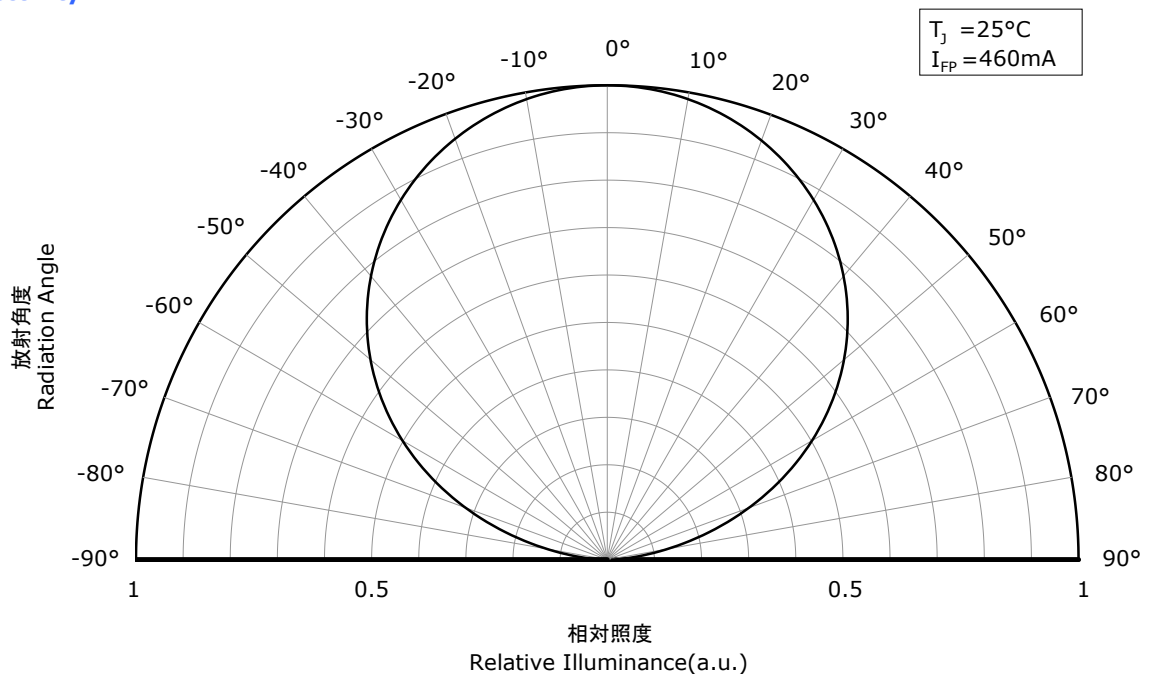

- * 本特性は演色性ランクR9050に対応しています。
The graphs above show the characteristics for R9050 LEDs of this product.

OPTICAL CHARACTERISTICS

- * 本特性は参考です。
All characteristics shown are for reference only and are not guaranteed.
- * パルス駆動により測定しています。
The following graphs show characteristics in pulse mode.

NFCWL060B-V2
管理番号 No. STS-DA7-10797

発光スペクトル Spectrum

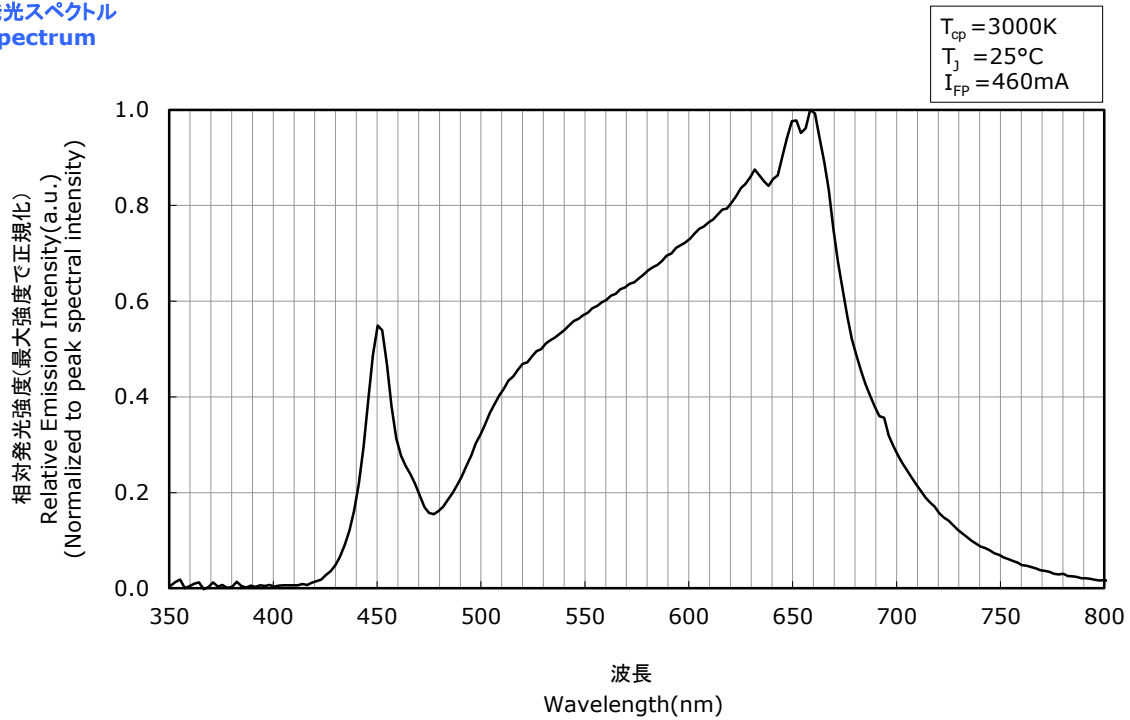

指向特性 Directivity

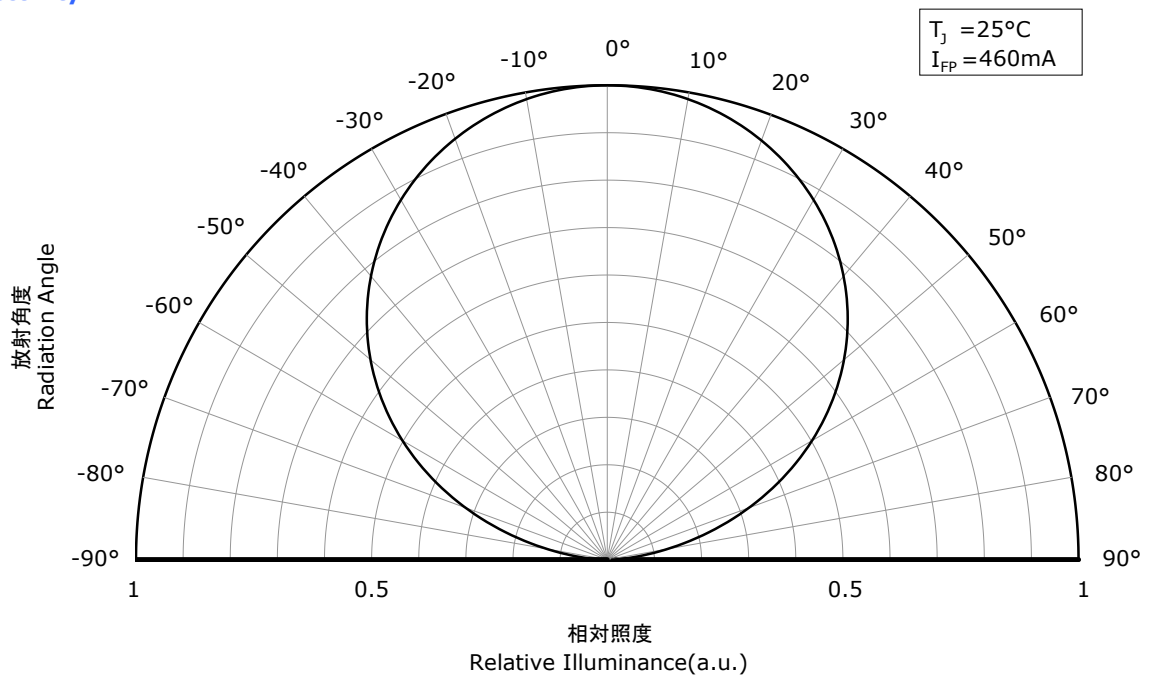

- * 本特性は演色性ランクR95に対応しています。
The graphs above show the characteristics for R95 LEDs of this product.

OPTICAL CHARACTERISTICS

- * 本特性は参考です。
All characteristics shown are for reference only and are not guaranteed.
- * パルス駆動により測定しています。
The following graphs show characteristics in pulse mode.

NFCWL060B-V2
管理番号 No. STS-DA7-10798

発光スペクトル Spectrum

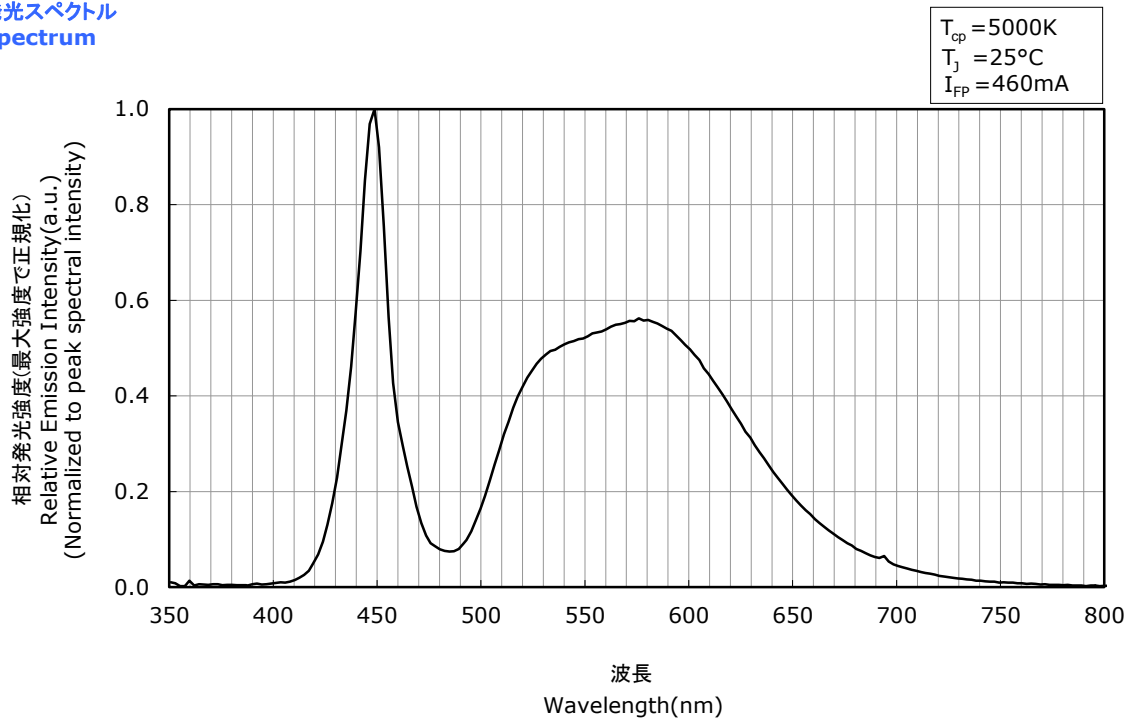

指向特性 Directivity

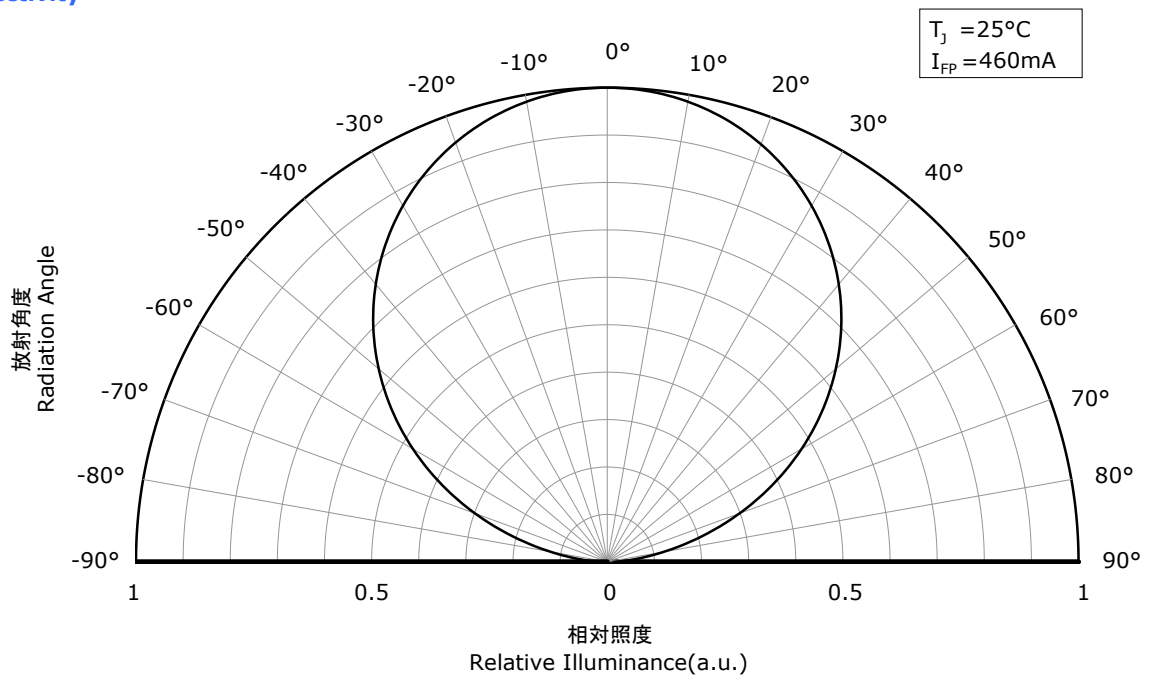

- * 本特性は演色性ランクR70に対応しています。
The graphs above show the characteristics for R70 LEDs of this product.

OPTICAL CHARACTERISTICS

- * 本特性は参考です。
All characteristics shown are for reference only and are not guaranteed.
- * パルス駆動により測定しています。
The following graphs show characteristics in pulse mode.

NFCWL060B-V2
管理番号 No. STS-DA7-10799

発光スペクトル Spectrum

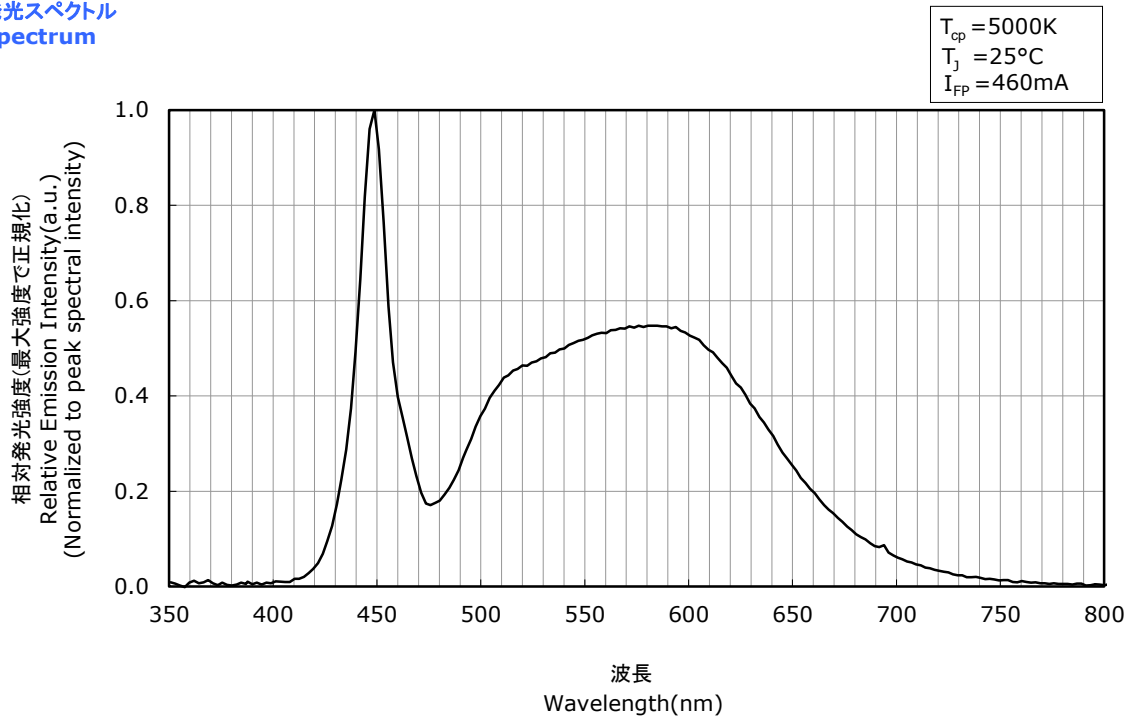

指向特性 Directivity

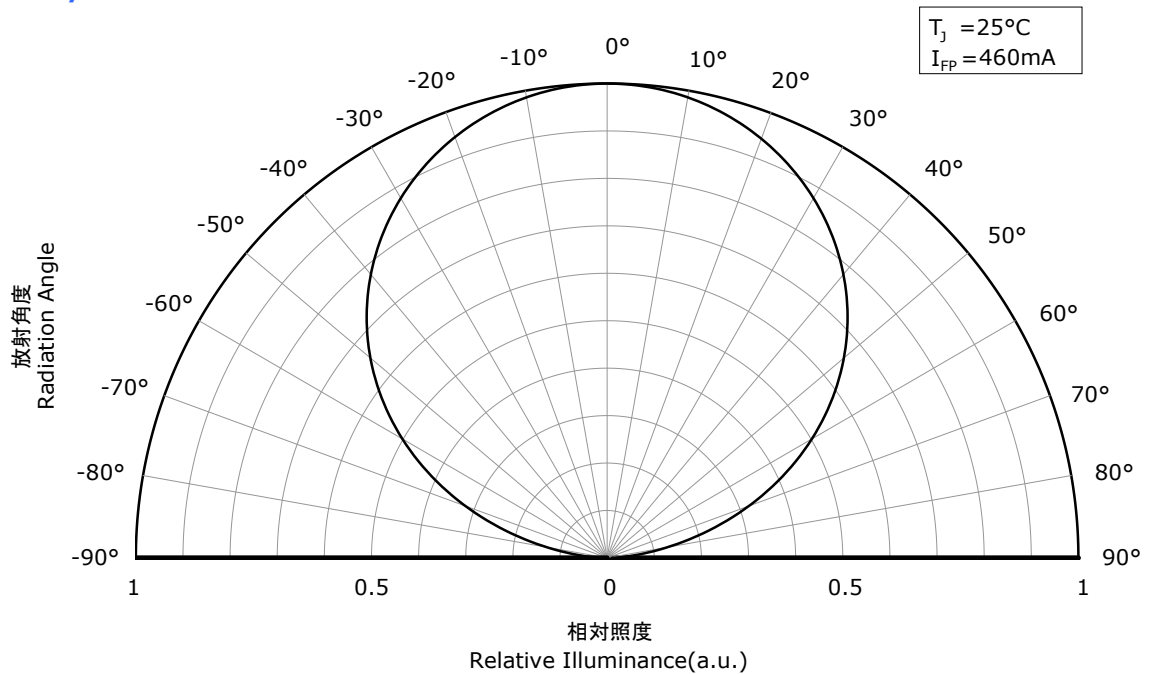

- * 本特性は演色性ランクR8000に対応しています。
The graphs above show the characteristics for R8000 LEDs of this product.

OPTICAL CHARACTERISTICS

- * 本特性は参考です。
All characteristics shown are for reference only and are not guaranteed.
- * パルス駆動により測定しています。
The following graphs show characteristics in pulse mode.

NFCWL060B-V2
管理番号 No. STS-DA7-10800

発光スペクトル Spectrum

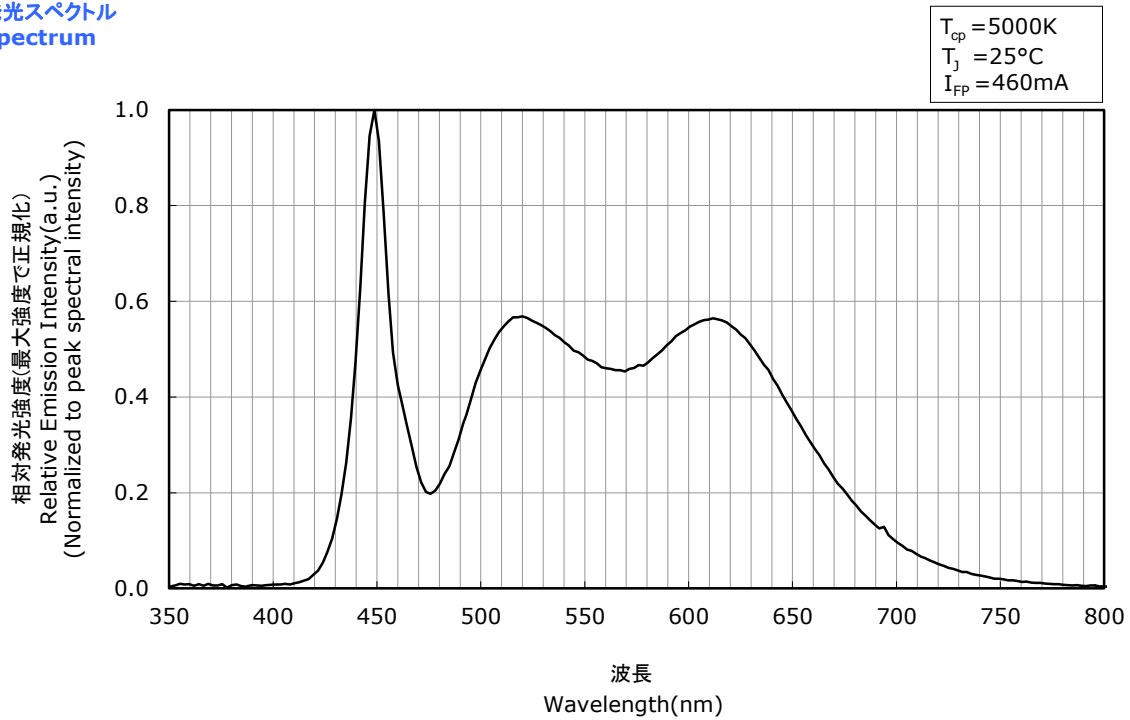

指向特性 Directivity

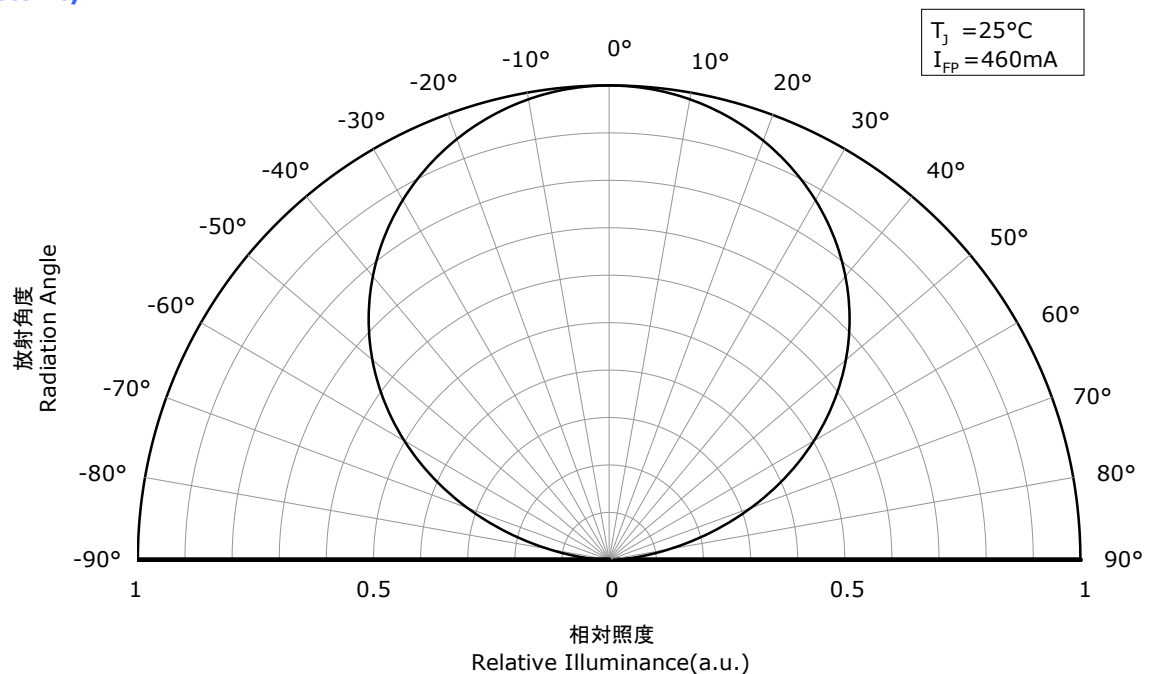

- * 本特性は演色性ランクR9050に対応しています。
The graphs above show the characteristics for R9050 LEDs of this product.

OPTICAL CHARACTERISTICS

- * 本特性は参考です。
All characteristics shown are for reference only and are not guaranteed.
- * パルス駆動により測定しています。
The following graphs show characteristics in pulse mode.

NFCWL060B-V2
管理番号 No. STS-DA7-10801

発光スペクトル Spectrum

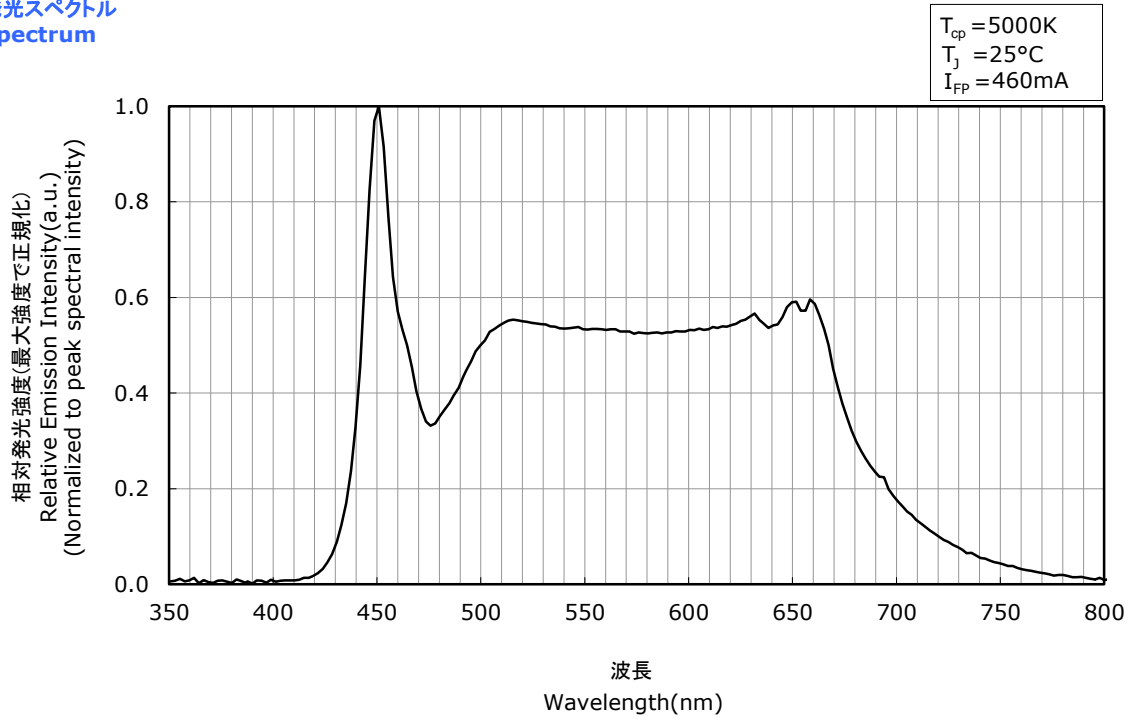

指向特性 Directivity

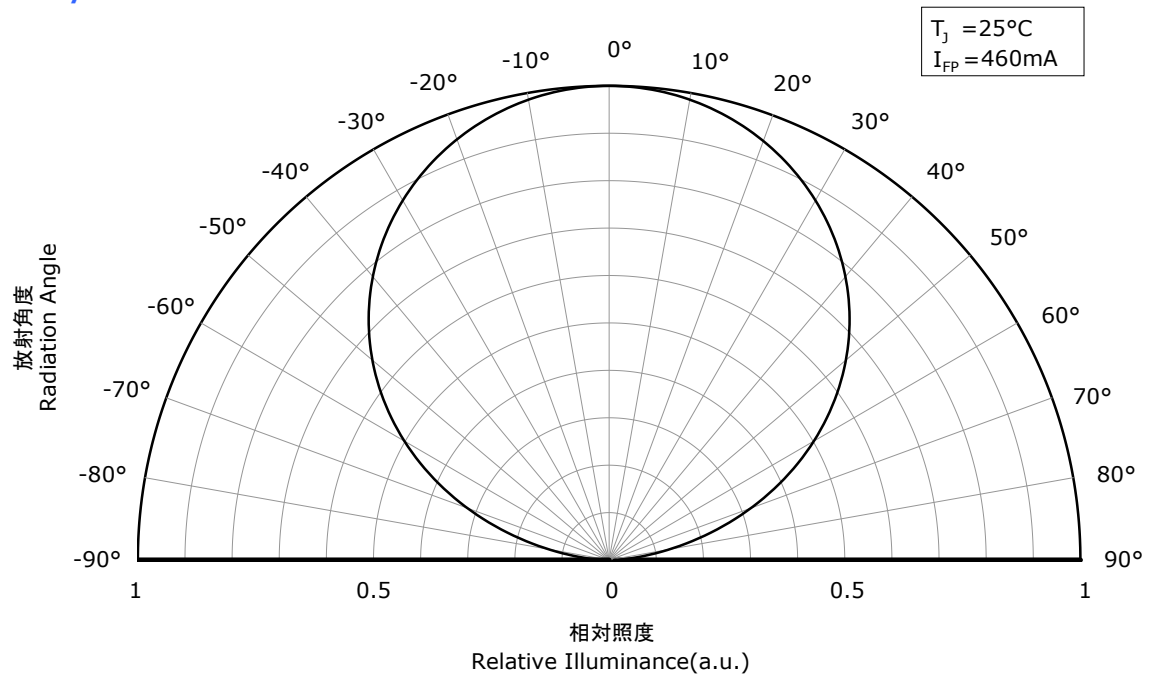

- * 本特性は演色性ランクR95に対応しています。
The graphs above show the characteristics for R95 LEDs of this product.

FORWARD CURRENT CHARACTERISTICS / TEMPERATURE CHARACTERISTICS

- * 本特性は参考です。
All characteristics shown are for reference only and are not guaranteed.
- * パルス駆動により測定しています。
The following graphs show characteristics in pulse mode.

NFCWL060B-V2
管理番号 No. STS-DA7-10802

順電圧-順電流特性
Forward Voltage vs
Forward Current

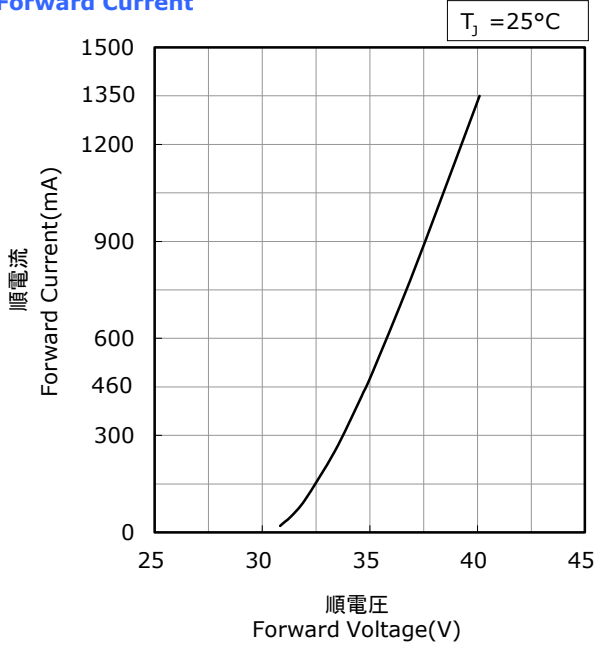

ジャンクション温度-順電圧特性
Junction Temperature vs
Forward Voltage

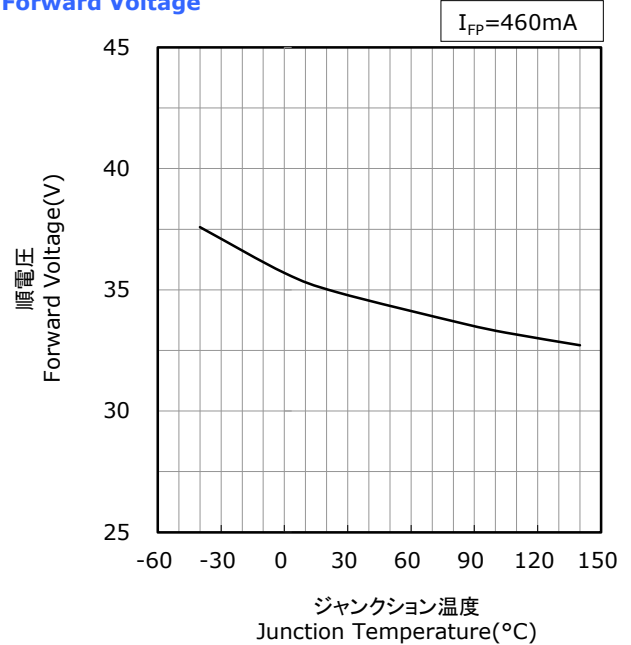

順電流-相対光束特性
Forward Current vs
Relative Luminous Flux

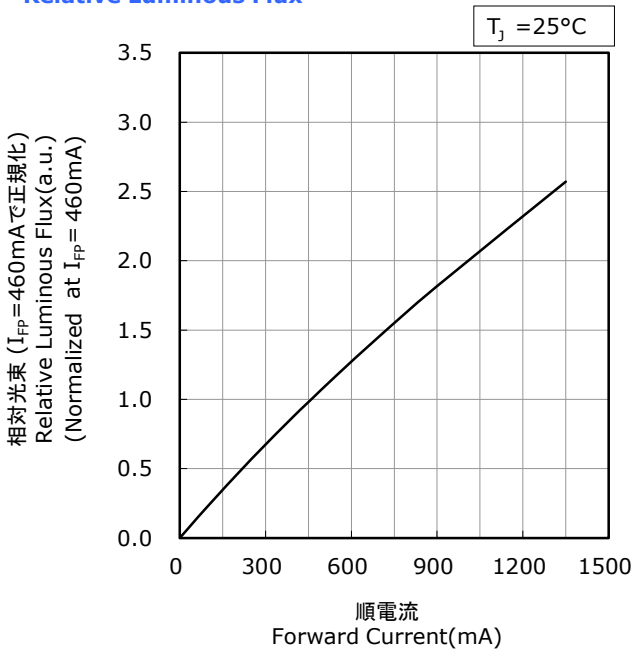

ジャンクション温度-相対光束特性
Junction Temperature vs
Relative Luminous Flux

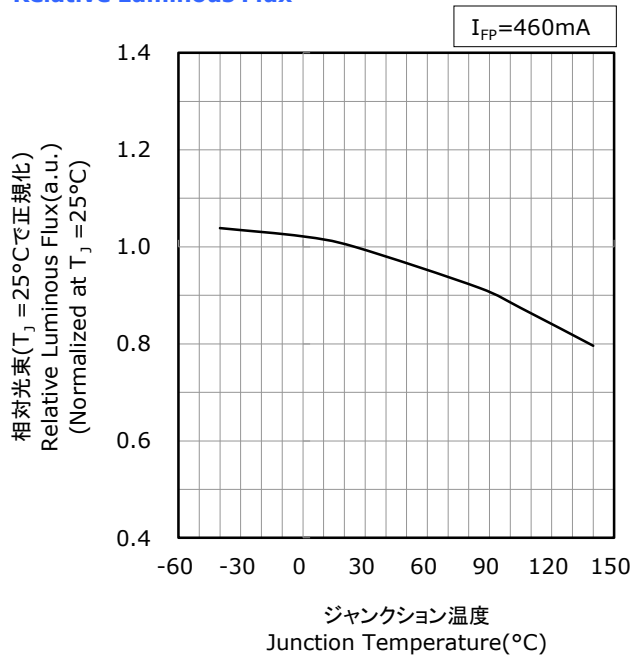

- * 本特性は色度ランクsm27x, sm30x, sm35x, sm40x, sm45x(ランク座標範囲内の特別ランクを含む)、演色性ランクR70 に対応しています。
The graphs above show the characteristics for sm27x, sm30x, sm35x, sm40x, sm45x, R70 LEDs, including sub-bins, of this product.

FORWARD CURRENT CHARACTERISTICS / TEMPERATURE CHARACTERISTICS

- * 本特性は参考です。
All characteristics shown are for reference only and are not guaranteed.
- * パルス駆動により測定しています。
The following graphs show characteristics in pulse mode.

NFCWL060B-V2
管理番号 No. STS-DA7-10803

順電圧-順電流特性
Forward Voltage vs
Forward Current

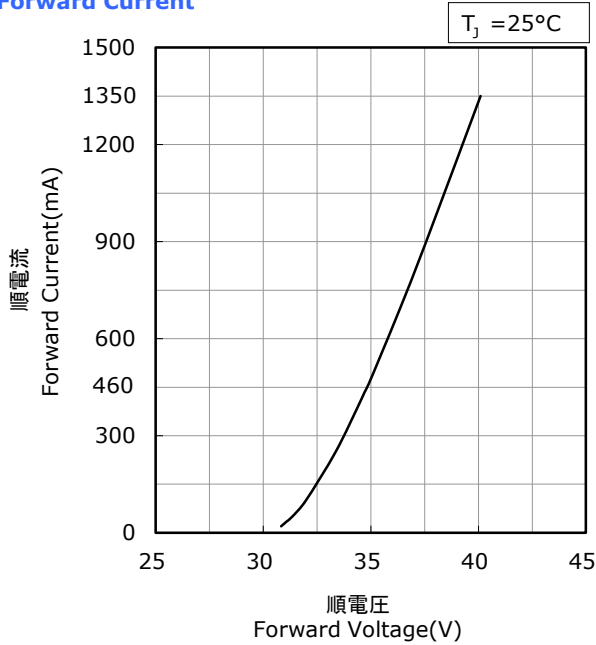

ジャンクション温度-順電圧特性
Junction Temperature vs
Forward Voltage

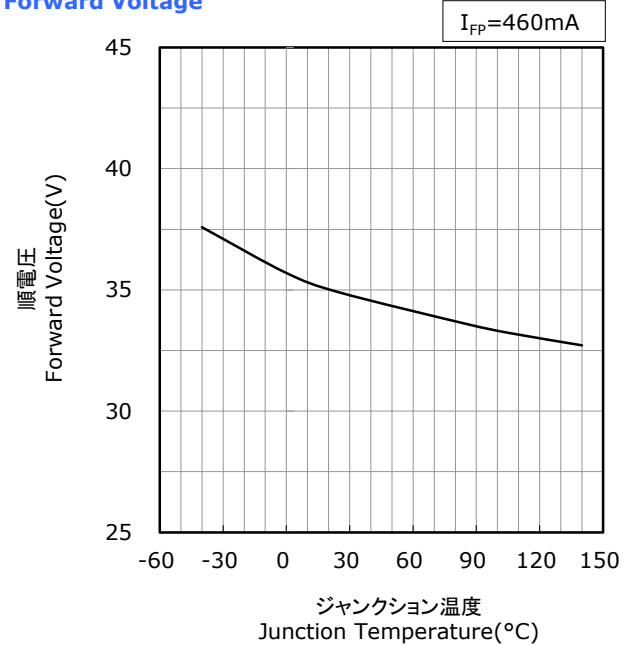

順電流-相対光束特性
Forward Current vs
Relative Luminous Flux

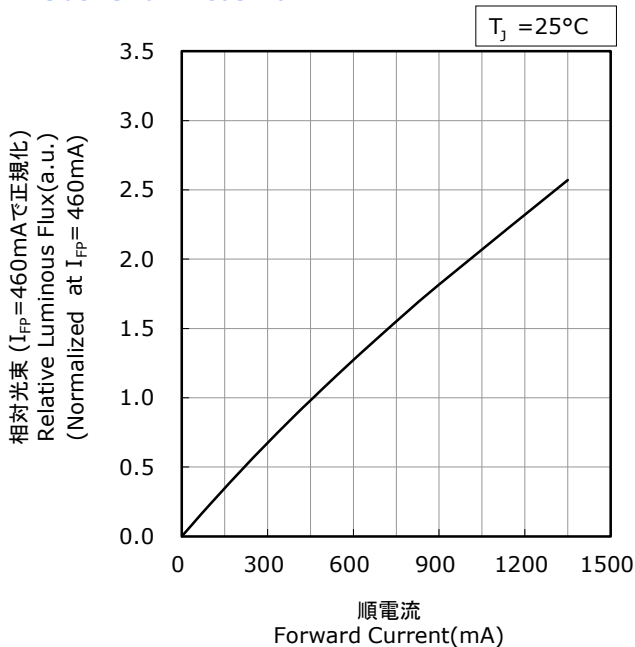

ジャンクション温度-相対光束特性
Junction Temperature vs
Relative Luminous Flux

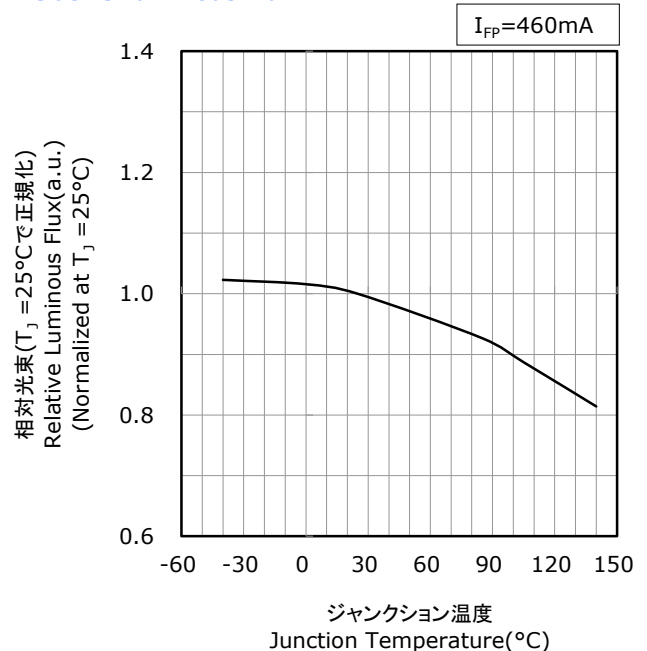

- * 本特性は色度ランクsm22x, sm25x, sm27x, sm30x, sm35x, sm40x, sm45x(ランク座標範囲内の特別ランクを含む)、演色性ランクR8000に対応しています。
The graphs above show the characteristics for sm22x, sm25x, sm27x, sm30x, sm35x, sm40x, sm45x, R8000 LEDs, including sub-bins, of this product.

FORWARD CURRENT CHARACTERISTICS / TEMPERATURE CHARACTERISTICS

- * 本特性は参考です。
All characteristics shown are for reference only and are not guaranteed.
- * パルス駆動により測定しています。
The following graphs show characteristics in pulse mode.

NFCWL060B-V2
管理番号 No. STS-DA7-10804

順電圧-順電流特性
Forward Voltage vs
Forward Current

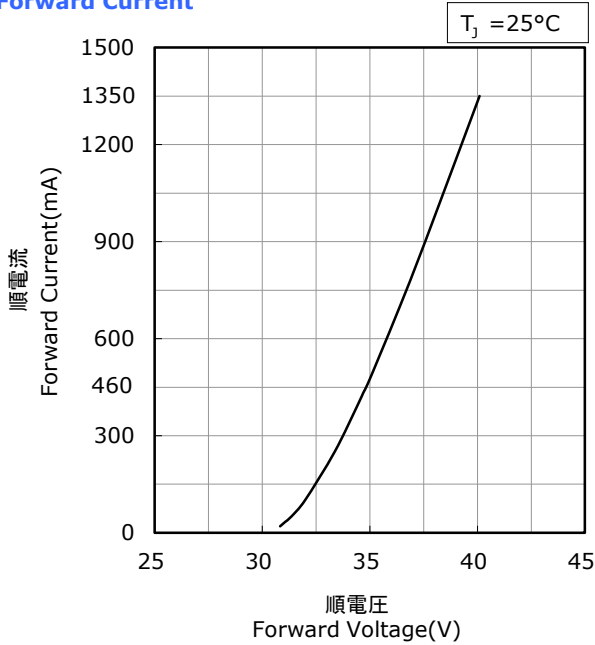

ジャンクション温度-順電圧特性
Junction Temperature vs
Forward Voltage

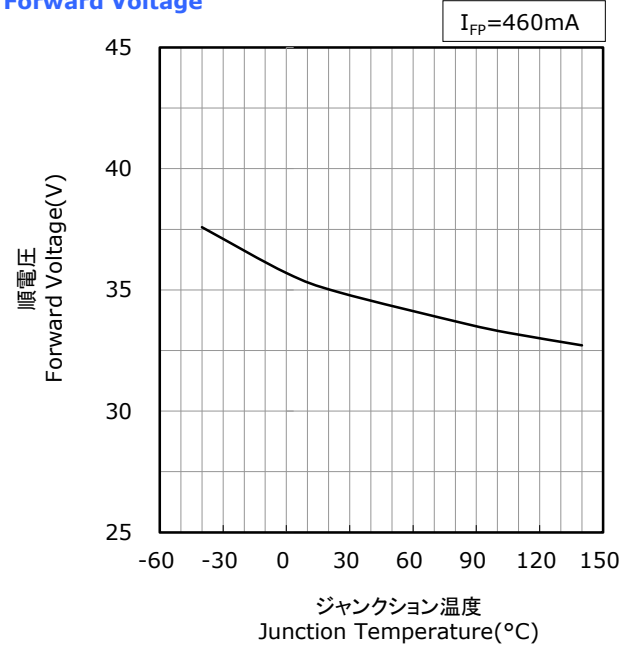

順電流-相対光束特性
Forward Current vs
Relative Luminous Flux

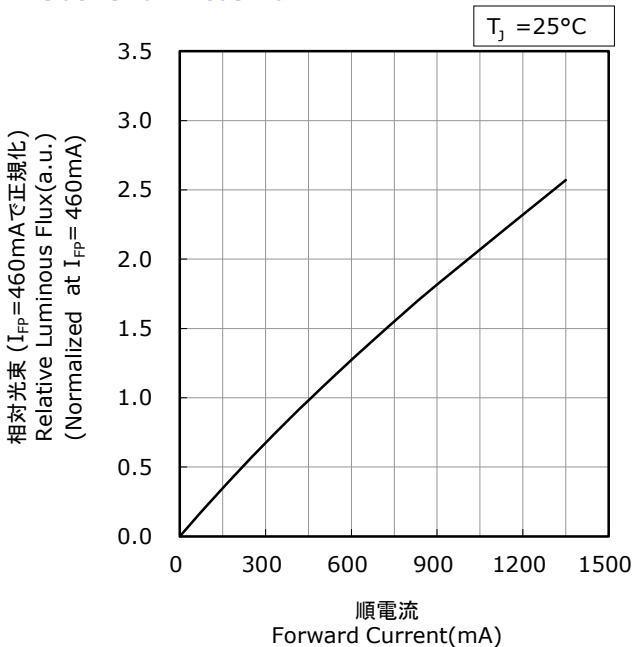

ジャンクション温度-相対光束特性
Junction Temperature vs
Relative Luminous Flux

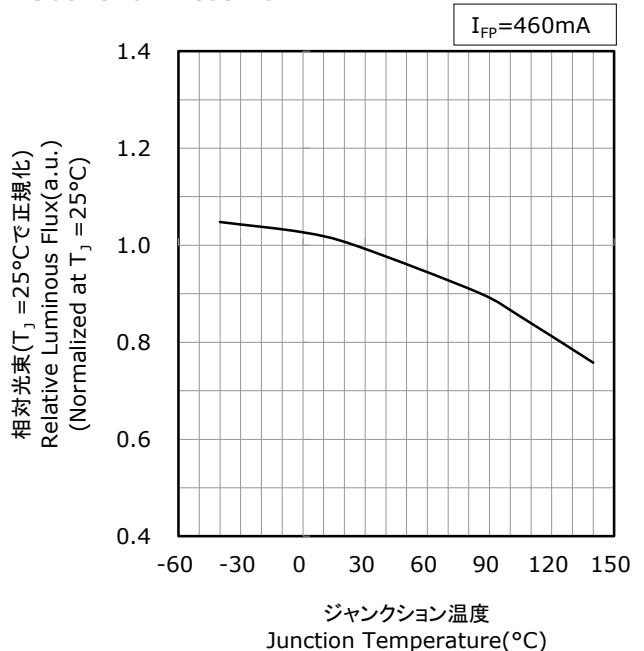

- * 本特性は色度ランクsm22x, sm25x, sm27x, sm30x, sm35x, sm40x, sm45x(ランク座標範囲内の特別ランクを含む)、
演色性ランクR9050に対応しています。
The graphs above show the characteristics for sm22x, sm25x, sm27x, sm30x, sm35x, sm40x, sm45x,
R9050 LEDs, including sub-bins, of this product.

FORWARD CURRENT CHARACTERISTICS / TEMPERATURE CHARACTERISTICS

- * 本特性は参考です。
All characteristics shown are for reference only and are not guaranteed.
- * パルス駆動により測定しています。
The following graphs show characteristics in pulse mode.

NFCWL060B-V2
管理番号 No. STS-DA7-10805

順電圧-順電流特性
Forward Voltage vs
Forward Current

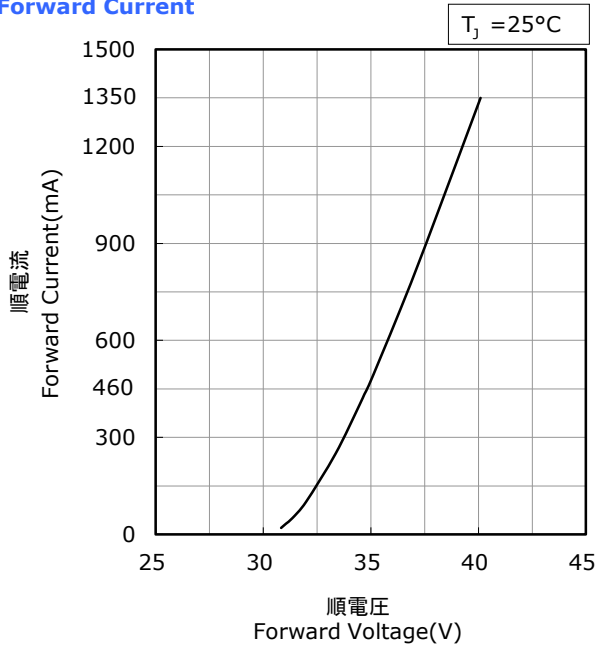

ジャンクション温度-順電圧特性
Junction Temperature vs
Forward Voltage

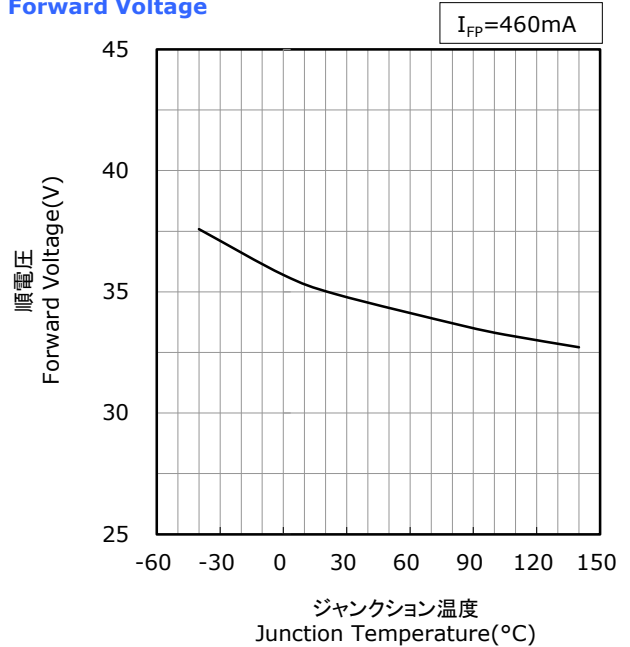

順電流-相対光束特性
Forward Current vs
Relative Luminous Flux

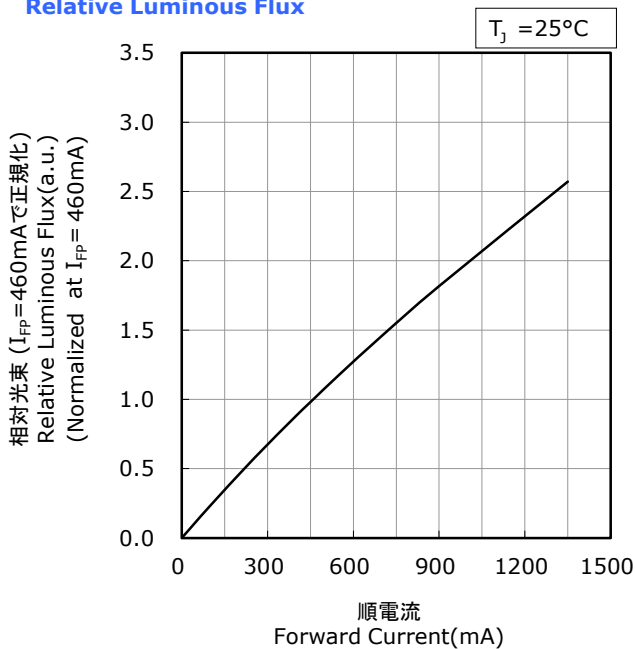

ジャンクション温度-相対光束特性
Junction Temperature vs
Relative Luminous Flux

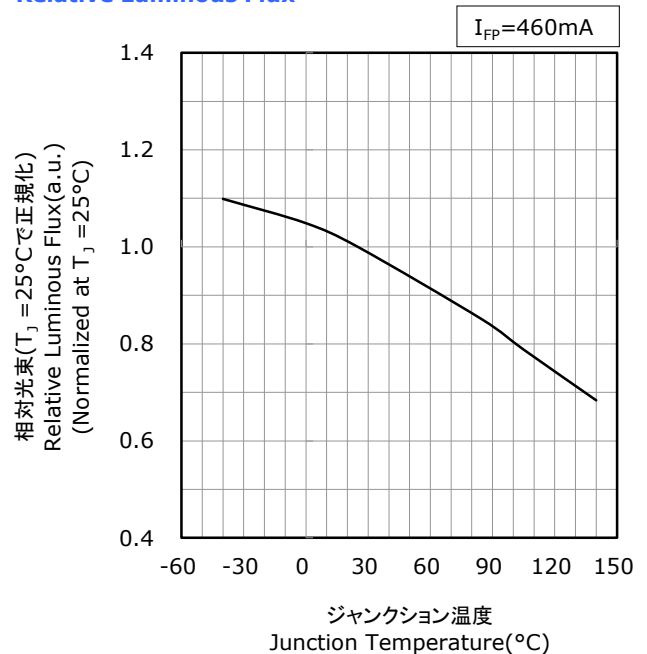

- * 本特性は色度ランクsm27x、sm30x、sm35x、sm40x、sm45x(ランク座標範囲内の特別ランクを含む)、演色性ランクR95 に対応しています。
The graphs above show the characteristics for sm27x, sm30x, sm35x, sm40x, sm45x, R95 LEDs, including sub-bins, of this product.

FORWARD CURRENT CHARACTERISTICS / TEMPERATURE CHARACTERISTICS

- * 本特性は参考です。
All characteristics shown are for reference only and are not guaranteed.
- * パルス駆動により測定しています。
The following graphs show characteristics in pulse mode.

NFCWL060B-V2
管理番号 No. STS-DA7-10806

順電圧-順電流特性
Forward Voltage vs
Forward Current

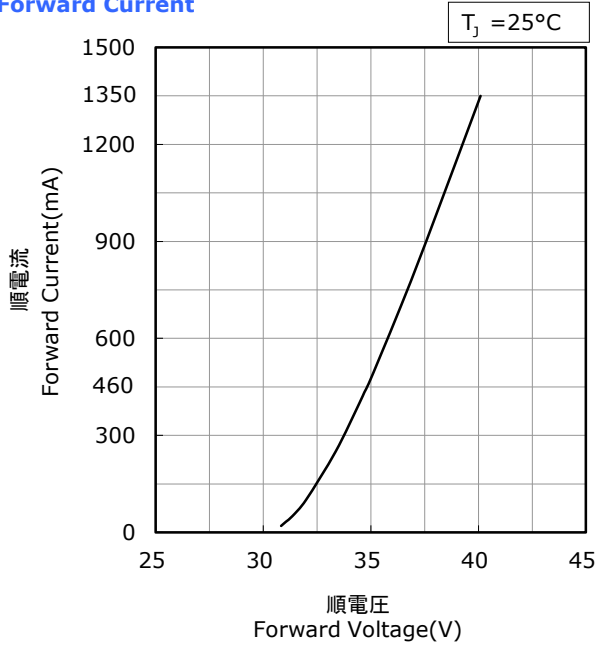

ジャンクション温度-順電圧特性
Junction Temperature vs
Forward Voltage

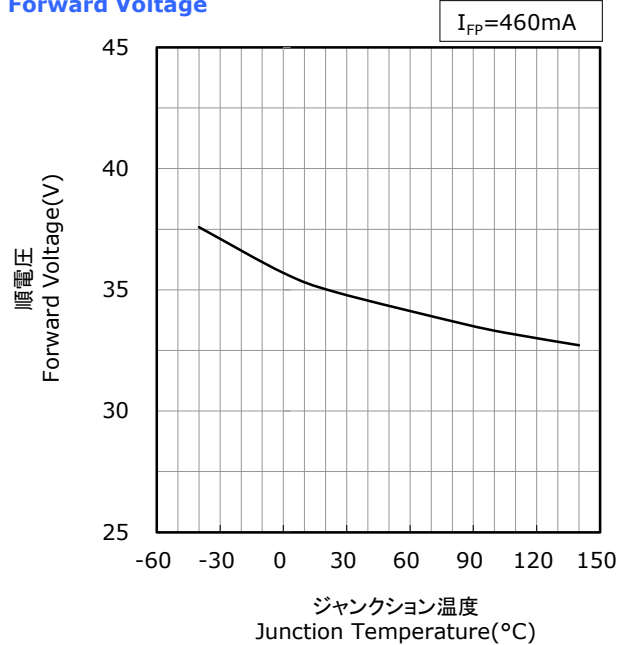

順電流-相対光束特性
Forward Current vs
Relative Luminous Flux

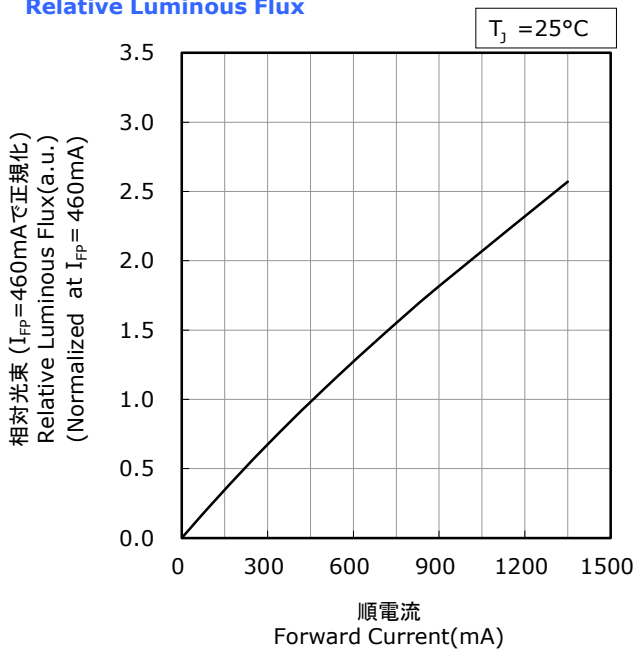

ジャンクション温度-相対光束特性
Junction Temperature vs
Relative Luminous Flux

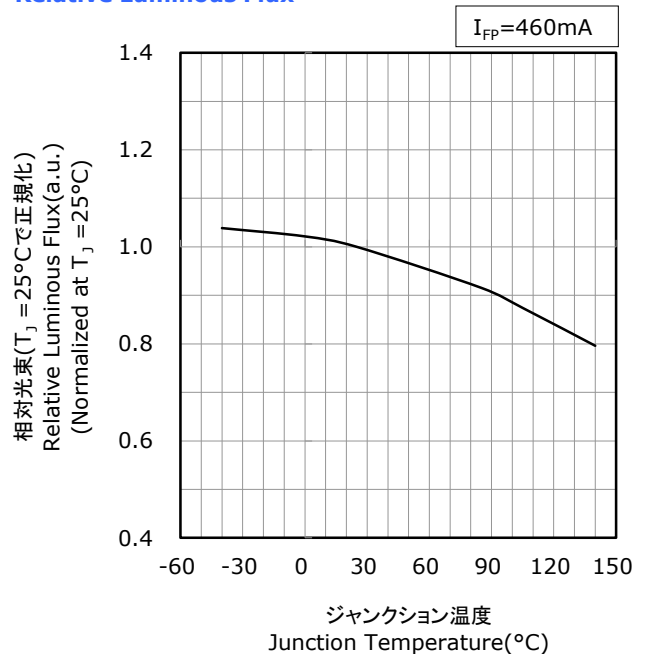

- * 本特性は色度ランクsm65x, sm57x, sm50x(ランク座標範囲内の特別ランクを含む)、演色性ランクR70 に対応しています。
The graphs above show the characteristics for sm65x, sm57x, sm50x, R70 LEDs, including sub-bins, of this product.

FORWARD CURRENT CHARACTERISTICS / TEMPERATURE CHARACTERISTICS

- * 本特性は参考です。
All characteristics shown are for reference only and are not guaranteed.
- * パルス駆動により測定しています。
The following graphs show characteristics in pulse mode.

NFCWL060B-V2
管理番号 No. STS-DA7-10807

順電圧-順電流特性
Forward Voltage vs
Forward Current

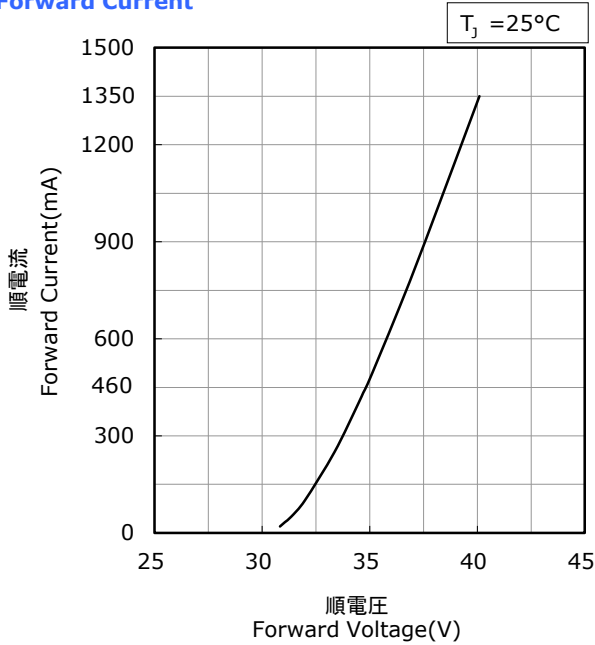

ジャンクション温度-順電圧特性
Junction Temperature vs
Forward Voltage

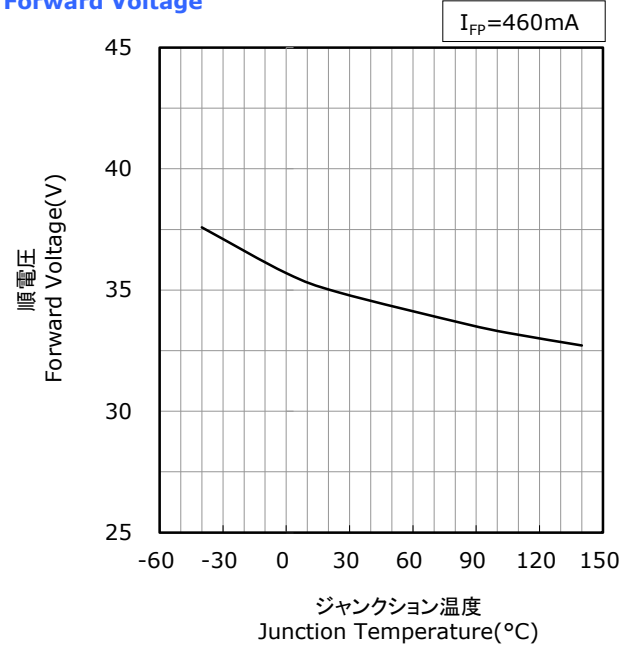

順電流-相対光束特性
Forward Current vs
Relative Luminous Flux

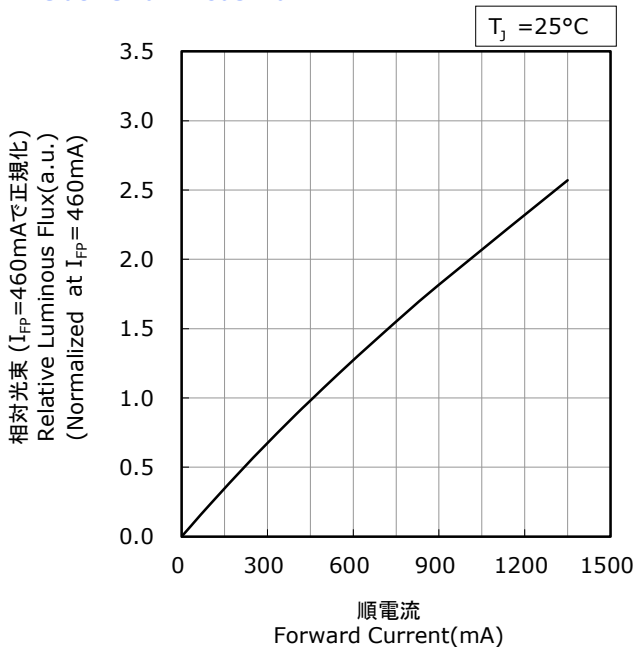

ジャンクション温度-相対光束特性
Junction Temperature vs
Relative Luminous Flux

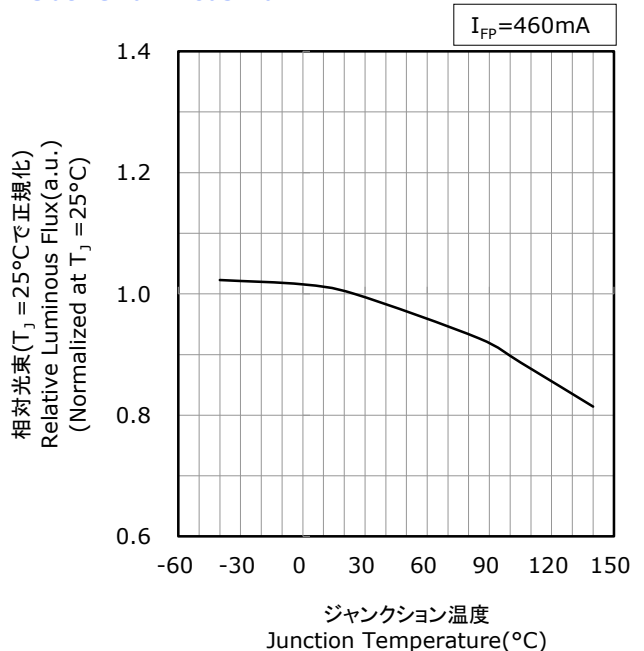

- * 本特性は色度ランクsm65x、sm57x、sm50x(ランク座標範囲内の特別ランクを含む)、演色性ランクR8000に対応しています。
The graphs above show the characteristics for sm65x, sm57x, sm50x, R8000 LEDs, including sub-bins, of this product.

FORWARD CURRENT CHARACTERISTICS / TEMPERATURE CHARACTERISTICS

- * 本特性は参考です。
All characteristics shown are for reference only and are not guaranteed.
- * パルス駆動により測定しています。
The following graphs show characteristics in pulse mode.

NFCWL060B-V2
管理番号 No. STS-DA7-10808

順電圧-順電流特性
Forward Voltage vs
Forward Current

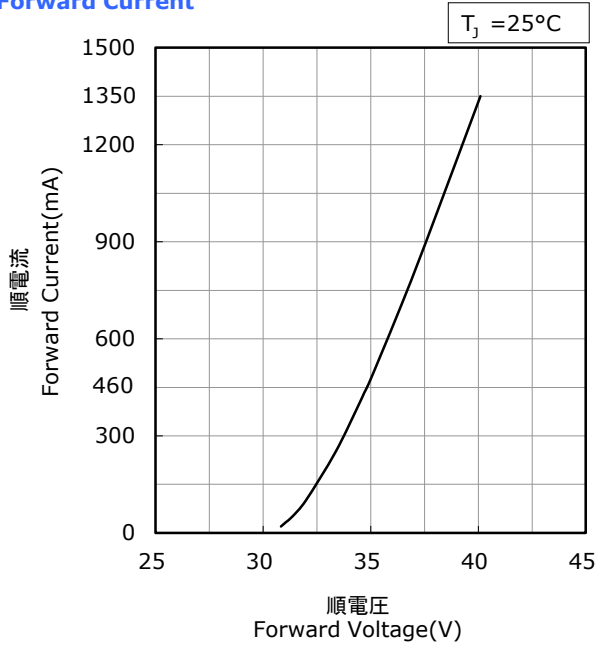

ジャンクション温度-順電圧特性
Junction Temperature vs
Forward Voltage

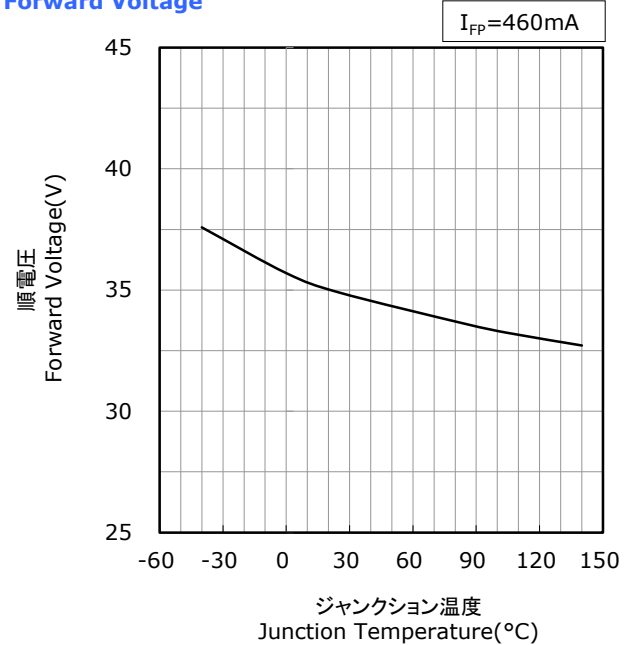

順電流-相対光束特性
Forward Current vs
Relative Luminous Flux

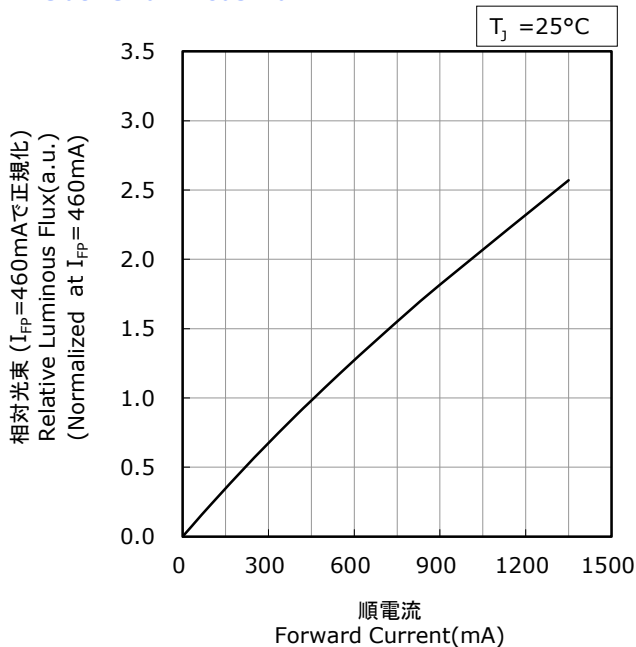

ジャンクション温度-相対光束特性
Junction Temperature vs
Relative Luminous Flux

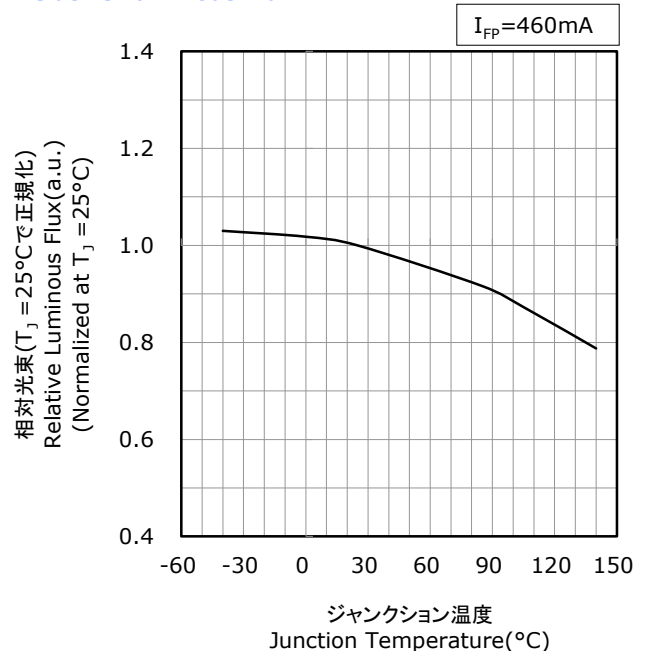

- * 本特性は色度ランクsm65x、sm57x、sm50x(ランク座標範囲内の特別ランクを含む)、演色性ランクR9050 に対応しています。
The graphs above show the characteristics for sm65x, sm57x, sm50x, R9050 LEDs, including sub-bins, of this product.

FORWARD CURRENT CHARACTERISTICS / TEMPERATURE CHARACTERISTICS

- * 本特性は参考です。
All characteristics shown are for reference only and are not guaranteed.
- * パルス駆動により測定しています。
The following graphs show characteristics in pulse mode.

NFCWL060B-V2
管理番号 No. STS-DA7-10809

順電圧-順電流特性
Forward Voltage vs
Forward Current

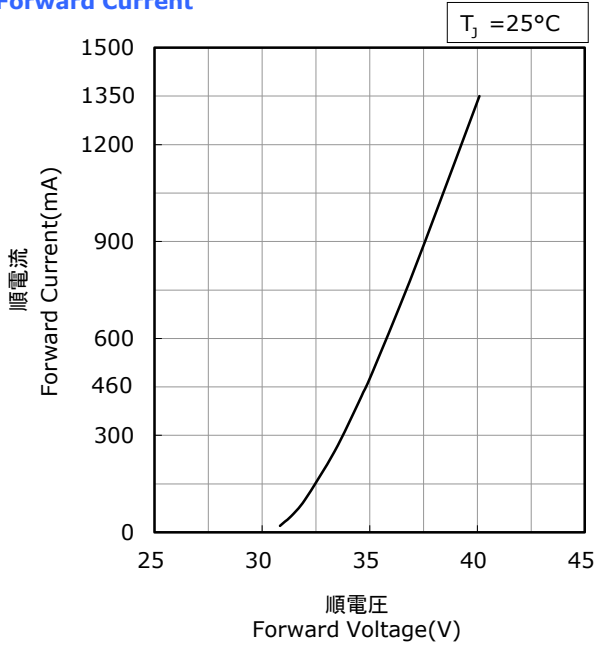

ジャンクション温度-順電圧特性
Junction Temperature vs
Forward Voltage

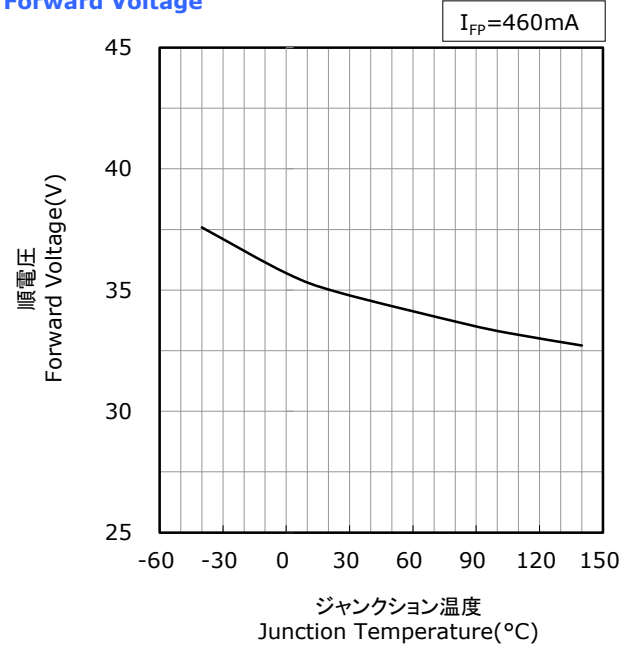

順電流-相対光束特性
Forward Current vs
Relative Luminous Flux

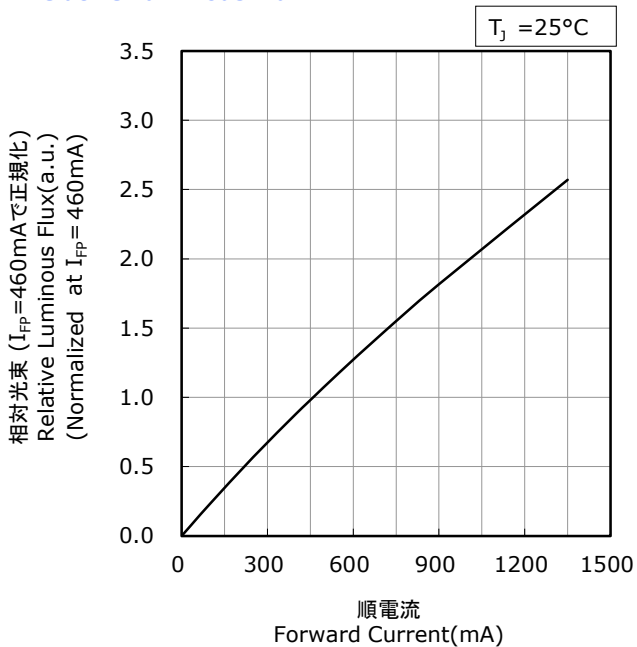

ジャンクション温度-相対光束特性
Junction Temperature vs
Relative Luminous Flux

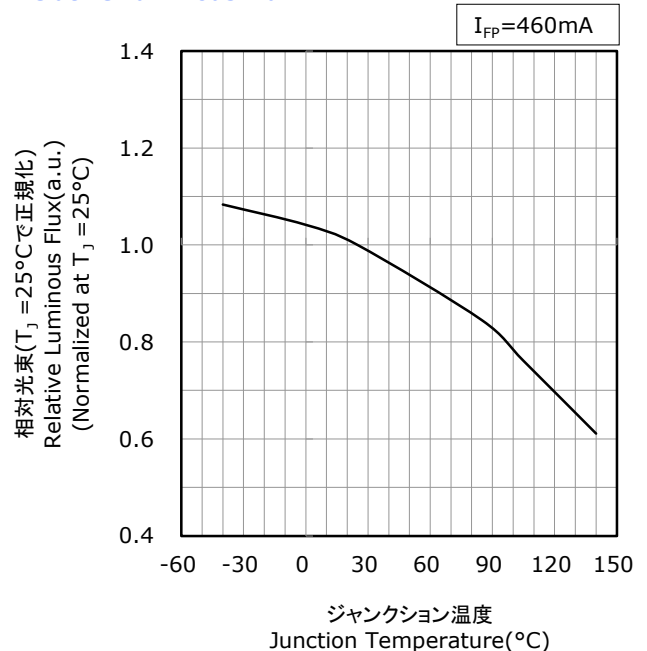

- * 本特性は色度ランクsm65x、sm57x、sm50x(ランク座標範囲内の特別ランクを含む)、演色性ランクR95 に対応しています。
The graphs above show the characteristics for sm65x, sm57x, sm50x, R95 LEDs, including sub-bins, of this product.

FORWARD CURRENT CHARACTERISTICS / TEMPERATURE CHARACTERISTICS

- * 本特性は参考です。
All characteristics shown are for reference only and are not guaranteed.
- * パルス駆動により測定しています。
The following graphs show characteristics in pulse mode.

NFCWL060B-V2
管理番号 No. STS-DA7-10810

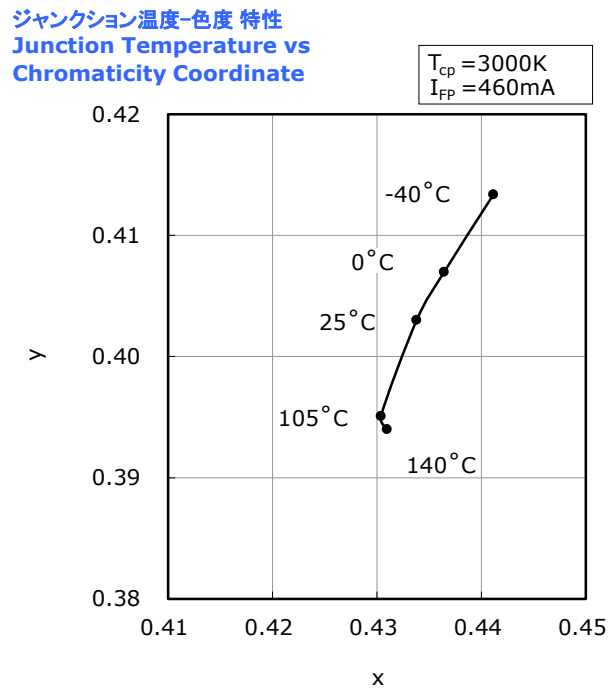
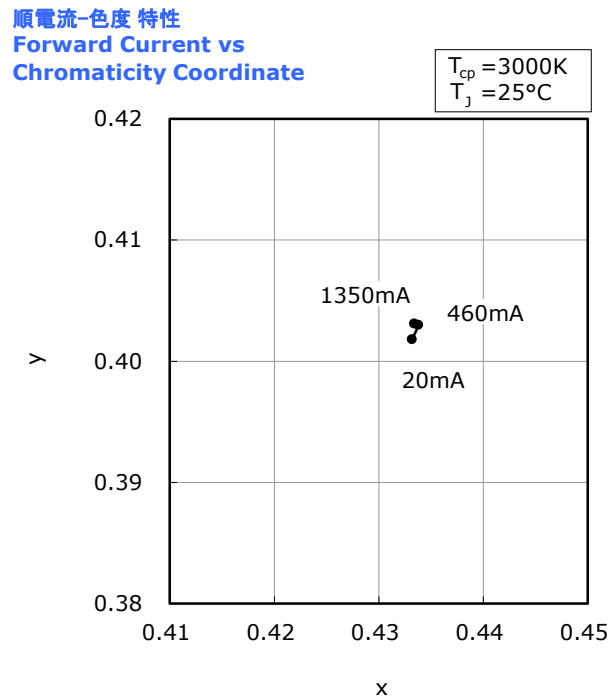

- * 本特性は演色性ランクR70に対応しています。
The graphs above show the characteristics for R70 LEDs of this product.

FORWARD CURRENT CHARACTERISTICS / TEMPERATURE CHARACTERISTICS

- * 本特性は参考です。
All characteristics shown are for reference only and are not guaranteed.
- * パルス駆動により測定しています。
The following graphs show characteristics in pulse mode.

NFCWL060B-V2
管理番号 No. STS-DA7-10811

順電流-色度 特性
Forward Current vs
Chromaticity Coordinate

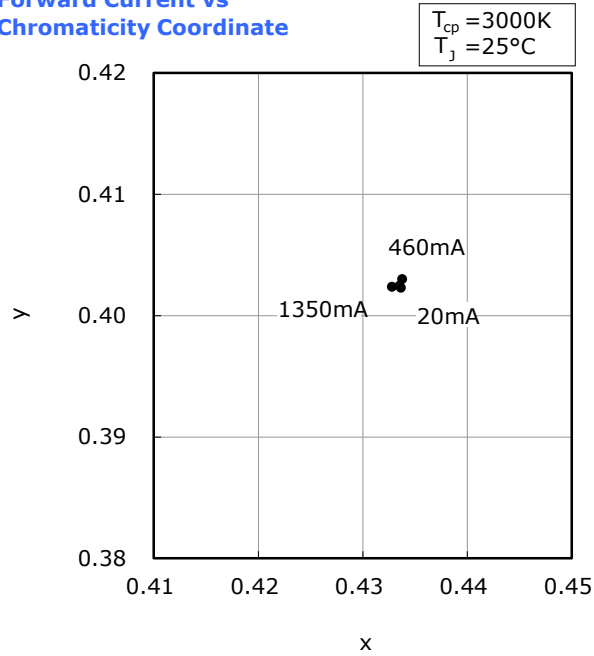

ジャンクション温度-色度 特性
Junction Temperature vs
Chromaticity Coordinate

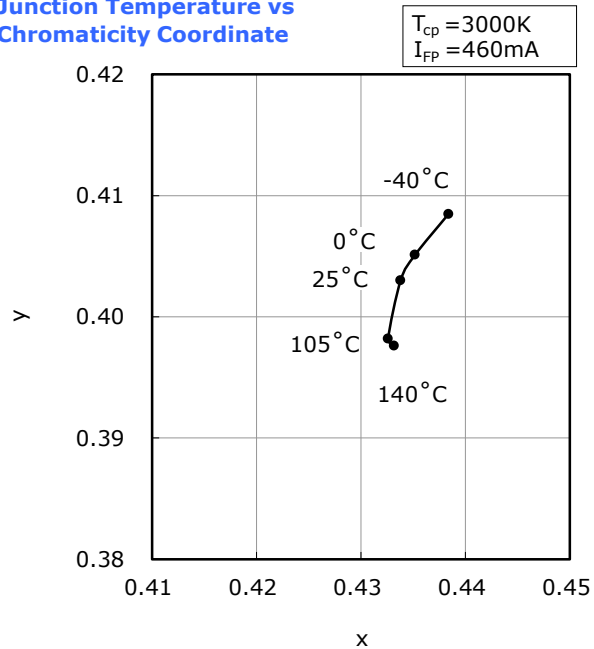

- * 本特性は演色性ランクR8000に対応しています。
The graphs above show the characteristics for R8000 LEDs of this product.

FORWARD CURRENT CHARACTERISTICS / TEMPERATURE CHARACTERISTICS

- * 本特性は参考です。
All characteristics shown are for reference only and are not guaranteed.
- * パルス駆動により測定しています。
The following graphs show characteristics in pulse mode.

NFCWL060B-V2
管理番号 No. STS-DA7-10812

順電流-色度 特性
Forward Current vs
Chromaticity Coordinate

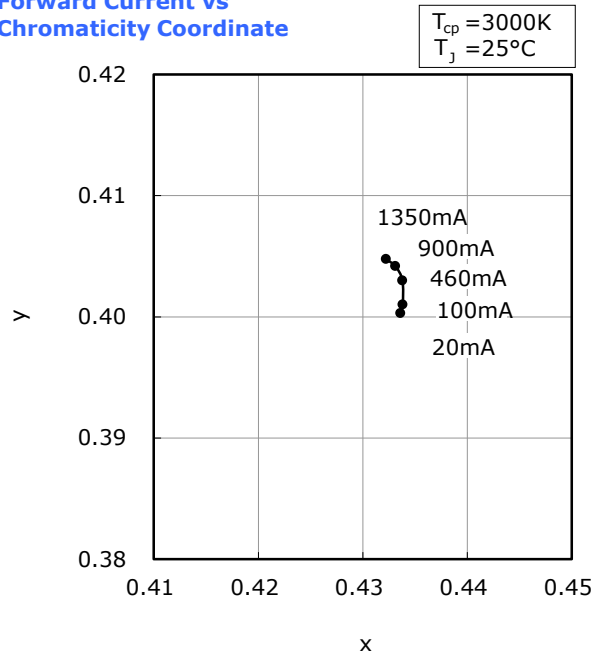

ジャンクション温度-色度 特性
Junction Temperature vs
Chromaticity Coordinate

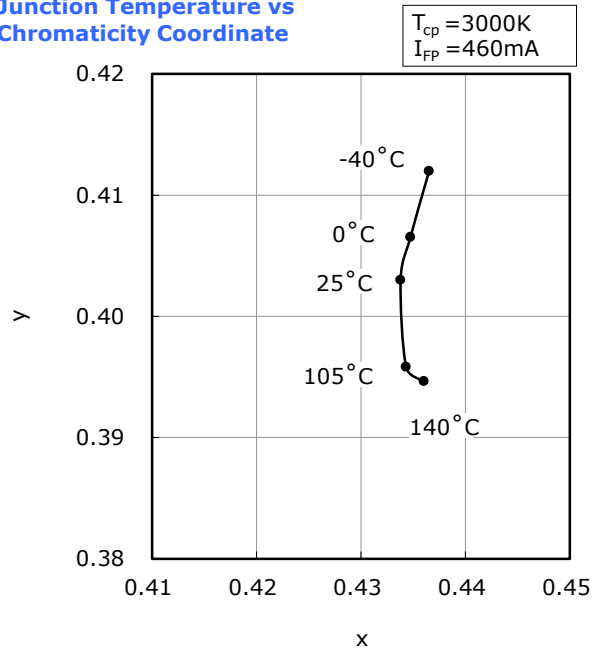

- * 本特性は演色性ランクR9050に対応しています。
The graphs above show the characteristics for R9050 LEDs of this product.

FORWARD CURRENT CHARACTERISTICS / TEMPERATURE CHARACTERISTICS

- * 本特性は参考です。
All characteristics shown are for reference only and are not guaranteed.
- * パルス駆動により測定しています。
The following graphs show characteristics in pulse mode.

NFCWL060B-V2
管理番号 No. STS-DA7-10813

順電流-色度 特性
Forward Current vs
Chromaticity Coordinate

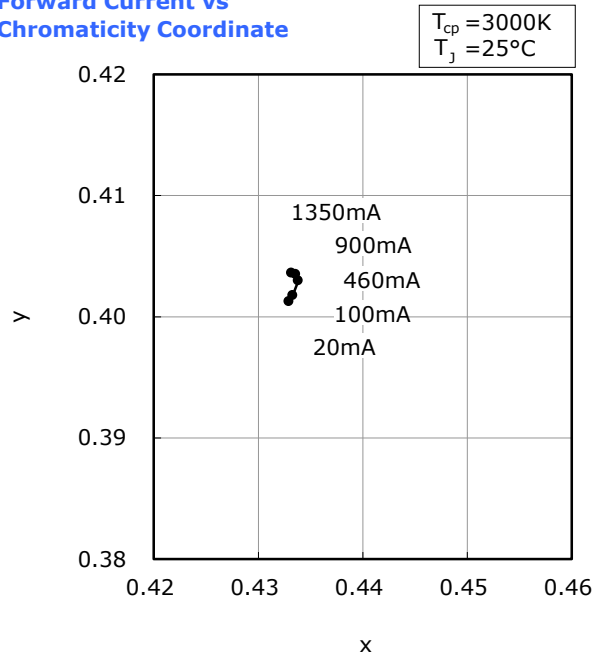

ジャンクション温度-色度 特性
Junction Temperature vs
Chromaticity Coordinate

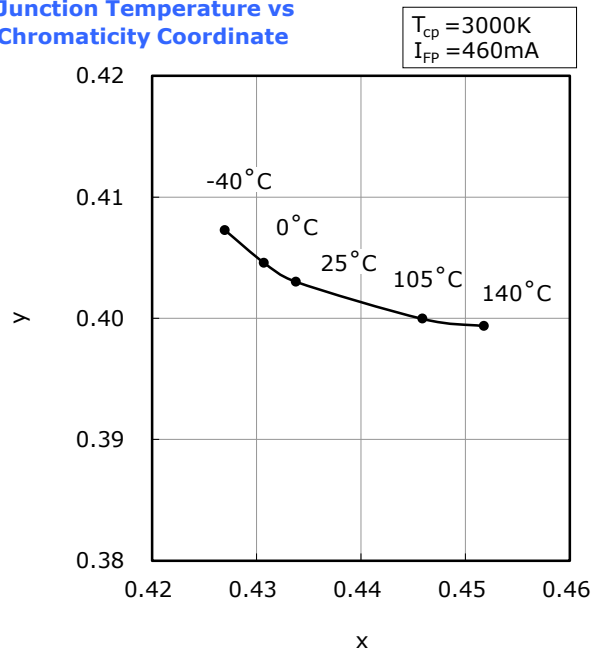

- * 本特性は演色性ランクR95に対応しています。
The graphs above show the characteristics for R95 LEDs of this product.

FORWARD CURRENT CHARACTERISTICS / TEMPERATURE CHARACTERISTICS

- * 本特性は参考です。
All characteristics shown are for reference only and are not guaranteed.
- * パルス駆動により測定しています。
The following graphs show characteristics in pulse mode.

NFCWL060B-V2
管理番号 No. STS-DA7-10814

順電流-色度 特性
Forward Current vs
Chromaticity Coordinate

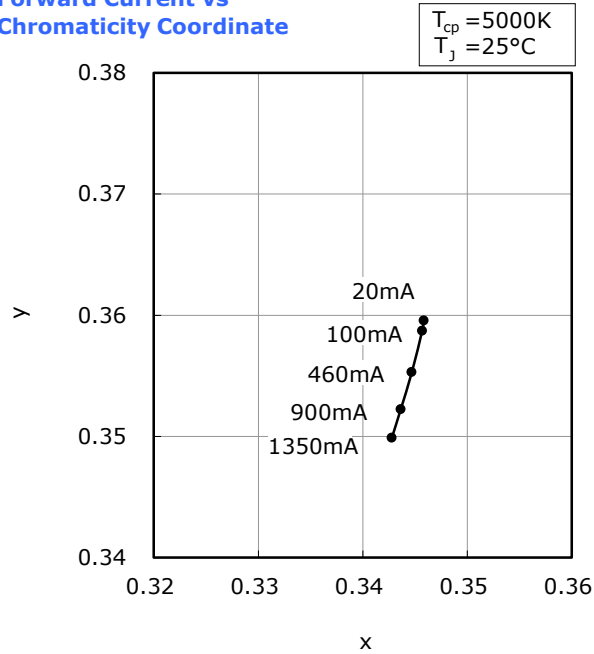

ジャンクション温度-色度 特性
Junction Temperature vs
Chromaticity Coordinate

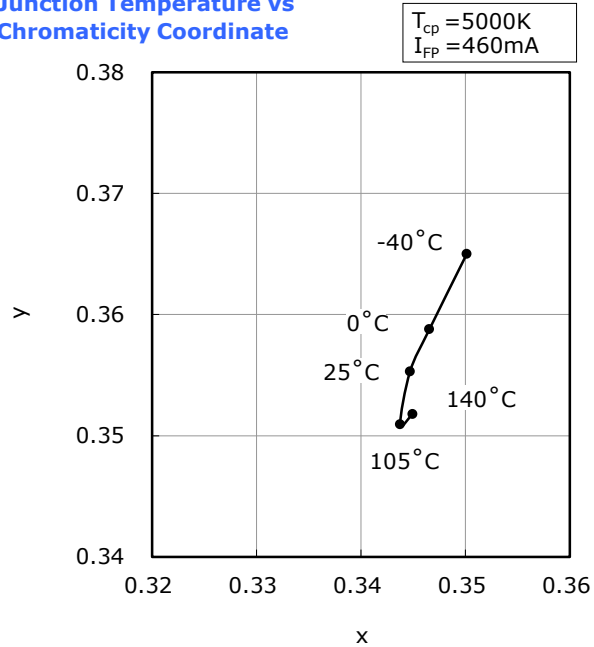

- * 本特性は演色性ランクR70に対応しています。
The graphs above show the characteristics for R70 LEDs of this product.

FORWARD CURRENT CHARACTERISTICS / TEMPERATURE CHARACTERISTICS

- * 本特性は参考です。
All characteristics shown are for reference only and are not guaranteed.
- * パルス駆動により測定しています。
The following graphs show characteristics in pulse mode.

NFCWL060B-V2
管理番号 No. STS-DA7-10815

順電流-色度 特性
Forward Current vs
Chromaticity Coordinate

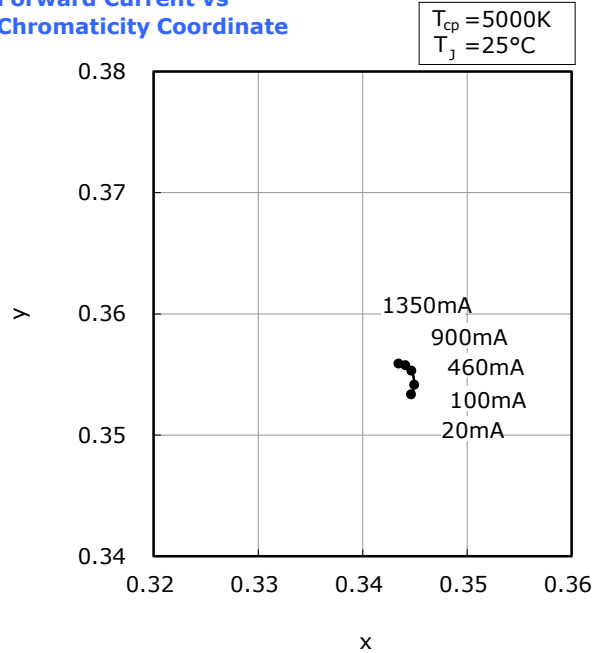

ジャンクション温度-色度 特性
Junction Temperature vs
Chromaticity Coordinate

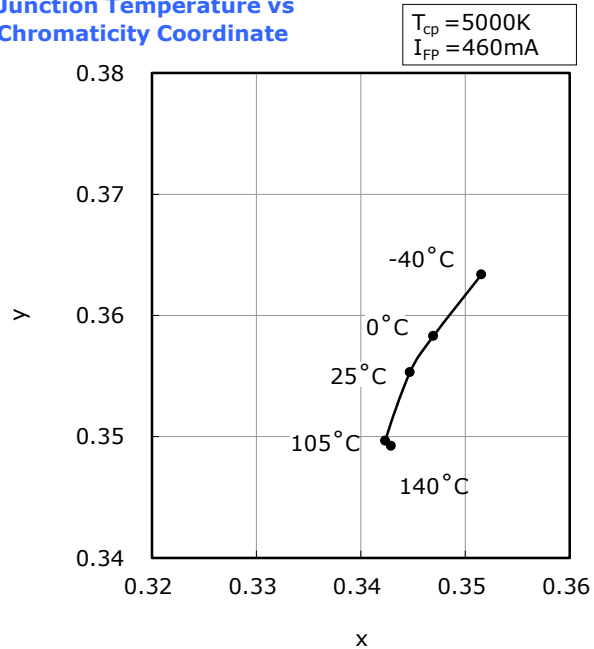

- * 本特性は演色性ランクR8000に対応しています。
The graphs above show the characteristics for R8000 LEDs of this product.

FORWARD CURRENT CHARACTERISTICS / TEMPERATURE CHARACTERISTICS

- * 本特性は参考です。
All characteristics shown are for reference only and are not guaranteed.
- * パルス駆動により測定しています。
The following graphs show characteristics in pulse mode.

NFCWL060B-V2
管理番号 No. STS-DA7-10816

順電流-色度 特性
Forward Current vs
Chromaticity Coordinate

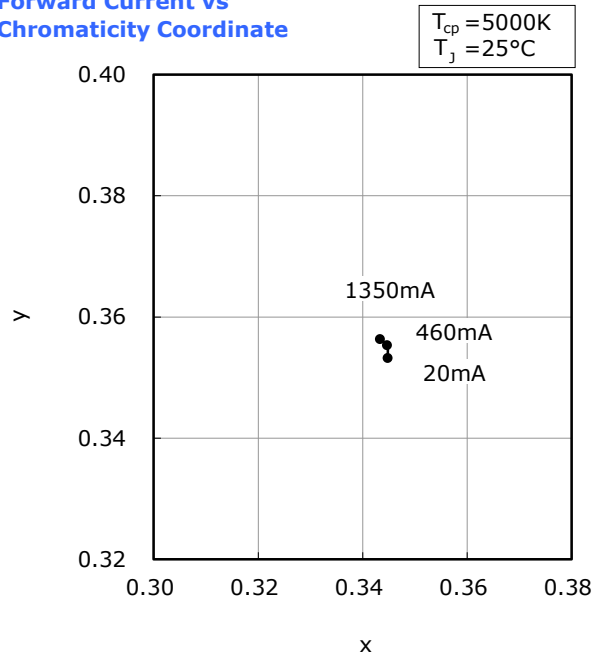

ジャンクション温度-色度 特性
Junction Temperature vs
Chromaticity Coordinate

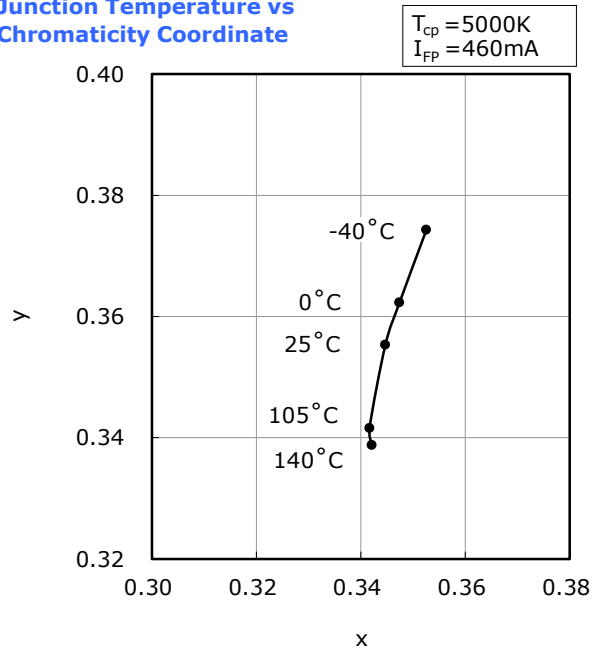

- * 本特性は演色性ランクR9050に対応しています。
The graphs above show the characteristics for R9050 LEDs of this product.

FORWARD CURRENT CHARACTERISTICS / TEMPERATURE CHARACTERISTICS

- * 本特性は参考です。
All characteristics shown are for reference only and are not guaranteed.
- * パルス駆動により測定しています。
The following graphs show characteristics in pulse mode.

NFCWL060B-V2
管理番号 No. STS-DA7-10817

順電流-色度 特性
Forward Current vs
Chromaticity Coordinate

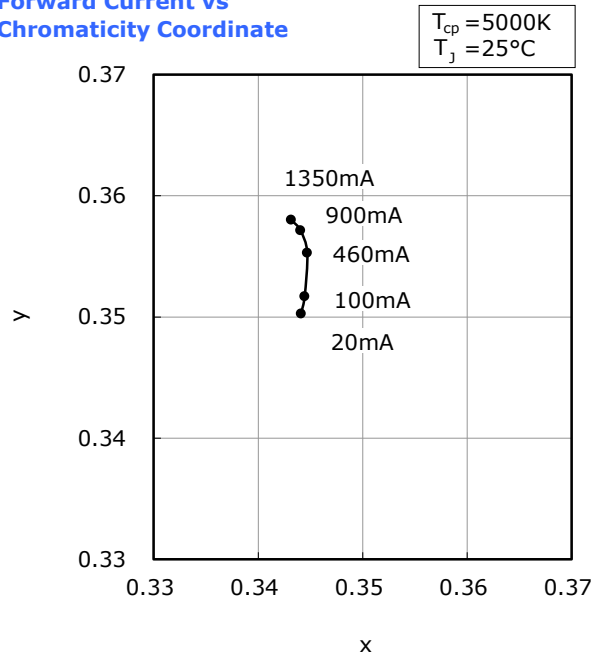

ジャンクション温度-色度 特性
Junction Temperature vs
Chromaticity Coordinate

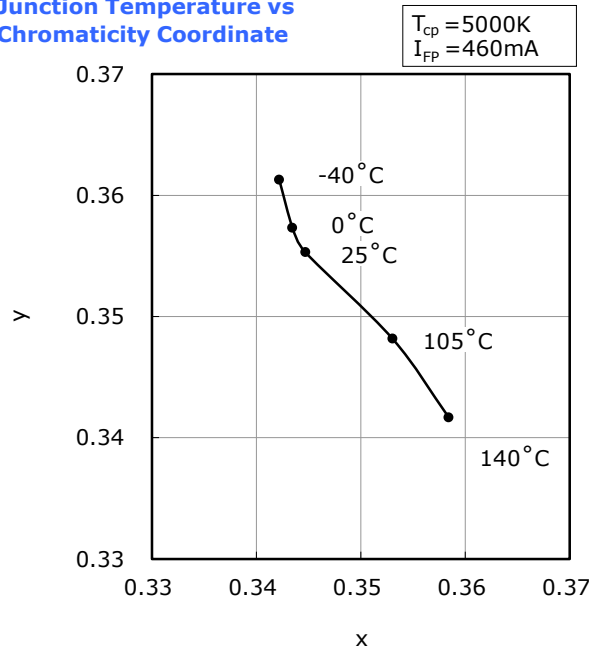

- * 本特性は演色性ランクR95に対応しています。
The graphs above show the characteristics for R95 LEDs of this product.

RELIABILITY

(1) Tests and Results

Test	Reference Standard	Test Conditions	Test Duration	Failure Criteria #	Units Failed/Tested
Temperature Cycle	JEITA ED-4701 100 105	-40°C(30min)~25°C(5min)~ 100°C(30min)~25°C(5min)	100cycles	#1	0/10
High Temperature Storage	JEITA ED-4701 200 201	T _A =100°C	1000hours	#1	0/10
Temperature Humidity Storage	JEITA ED-4701 100 103	T _A =60°C, RH=90%	1000hours	#1	0/10
Low Temperature Storage	JEITA ED-4701 200 202	T _A =-40°C	1000hours	#1	0/10
High Temperature Operating Life		T _C =82°C, I _F =900mA	1000hours	#1	0/10
Electrostatic Discharges	JEITA ED-4701 300 304	HBM, 2kV, 1.5kΩ, 100pF, 3pulses, alternately positive or negative		#1	0/10

NOTES:

Measurements are performed after allowing the LEDs to return to room temperature.

(2) Failure Criteria

Criteria #	Items	Conditions	Failure Criteria
#1	Forward Voltage(V _F)	I _F =460mA	>Initial value×1.1
	Luminous Flux(Φ _V)	I _F =460mA	<Initial value×0.7

CAUTIONS

(1) Storage

Conditions		Temperature	Humidity	Time
Storage	Before Opening Aluminum Bag	≤30°C	≤90%RH	Within 1 Year from Delivery Date
	After Opening Aluminum Bag	≤30°C	≤70%RH	≤168hours

- After opening the moisture-proof aluminum bag, the products should go through the soldering process within the range of the conditions stated above. Unused remaining LEDs should be stored with silica gel desiccants in a hermetically sealed container, preferably the original moisture-proof bags for storage.
- Although the leads or electrode pads (anode and cathode) of the product are plated with gold, prolonged exposure to a corrosive environment might cause the gold plated the leads or electrode pads to tarnish. If unused LEDs remain, they must be stored in a hermetically sealed container. Nichia recommends using the original moisture-proof bag for storage.
- Do not use sulfur-containing materials in commercial products. Some materials, such as seals and adhesives, may contain sulfur. The contaminated plating of LEDs might cause an open circuit. Silicone rubber is recommended as a material for seals. Bear in mind, the use of silicones may lead to silicone contamination of electrical contacts inside the products, caused by low molecular weight volatile siloxane.
- To prevent water condensation, please avoid large temperature and humidity fluctuations for the storage conditions.
- Do not store the LEDs in a dusty environment.
- Do not expose the LEDs to direct sunlight and/or an environment where the temperature is higher than normal room temperature.

(2) Directions for Use

- When designing a circuit, the current through each LED must not exceed the Absolute Maximum Rating. Operating at a constant current per LED is recommended. In case of operating at a constant voltage, Circuit B is recommended. If the LEDs are operated with constant voltage using Circuit A, the current through the LEDs may vary due to the variation in Forward Voltage characteristics of the LEDs.

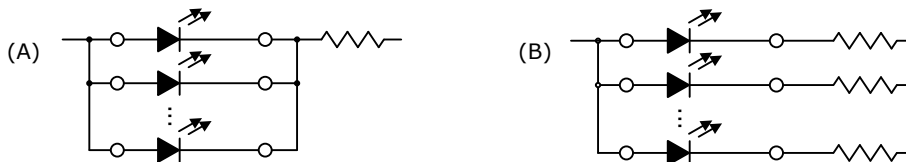

- This product should be operated using forward current. Ensure that the product is not subjected to either forward or reverse voltage while it is not in use. In particular, subjecting it to continuous reverse voltage may cause migration, which may cause damage to the LED die. When used in displays that are not used for a long time, the main power supply should be switched off for safety.
- Pulse width modulation (PWM) is recommended for dimming LEDs as color point changes with drive current.
- It is recommended to operate the LEDs at a current greater than 10% of the sorting current to stabilize the LED characteristics.
- Ensure that excessive voltages such as lightning surges are not applied to the LEDs.
- For outdoor use, necessary measures should be taken to prevent water, moisture and salt air damage.

(3) Handling Precautions

- Do not handle the LEDs with bare hands as it will contaminate the LED surface and may affect the optical characteristics: it might cause the LED to be deformed and/or the wire to break, which will cause the LED not to illuminate.
- When handling the product with tweezers, be careful not to apply excessive force to the resin. Otherwise, The resin can be cut, chipped, delaminate or deformed, causing wire-bond breaks and catastrophic failures.
- Dropping the product may cause damage.
- Do not stack assembled the products. Failure to comply can cause the resin portion of the product to be cut, chipped, delaminated and/or deformed. It may cause wire to break, leading to catastrophic failures.

(4) Design Consideration

- Volatile organic compounds that have been released from materials present around the LEDs (e.g. housing, packing, adhesive, secondary lens, lens cover, etc.) may penetrate the LED lens and/or encapsulating resin.
If the LEDs are being used in a hermetically sealed environment, these volatile compounds can discolor after being exposed to heat and/or photon energy and it may greatly reduce the LED light output and/or cause a color shift.
In this case, ventilating the environment may improve the reduction in light output and/or color shift.
Perform a light-up test of the chosen application for optical evaluation to ensure that there are no issues, especially if the LEDs are planned to be used in a hermetically sealed environment.
- Excessive forces on this product can cause the ceramic package to crack.
It is recommended to use a holder when fixing this product to a chassis.
- It is recommended to use a thermal film or thermal grease between the product and a chassis for increased heat dissipation.

(5) Electrostatic Discharge (ESD)

- The products are sensitive to static electricity or surge voltage. ESD can damage a die and its reliability.
When handling the products, the following measures against electrostatic discharge are strongly recommended:
 - Eliminating the charge
 - Grounded wrist strap, ESD footwear, clothes, and floors
 - Grounded workstation equipment and tools
 - ESD table/shelf mat made of conductive materials
- Ensure that tools (e.g. soldering irons), jigs and machines that are being used are properly grounded and that proper grounding techniques are used in work areas. For devices/equipment that mount the LEDs, protection against surge voltages should also be used.
- If tools or equipment contain insulating materials such as glass or plastic, the following measures against electrostatic discharge are strongly recommended:
 - Dissipating static charge with conductive materials
 - Preventing charge generation with moisture
 - Neutralizing the charge with ionizers

(6) Thermal Management

- When using this product, ensure that proper thermal management is provided and the die temperature does not exceed the maximum Junction Temperature (T_J).

The temperature at the LED junction, once the saturation temperature has been reached, can be calculated using the following equation:

$$T_J = T_C + R_{\theta JC} \cdot W$$

* T_J =LED junction temperature: °C

T_C =Case temperature: °C

$R_{\theta JC}$ =Thermal resistance from junction to T_C measurement point: °C/W

W =Input power($I_F \times V_F$): W

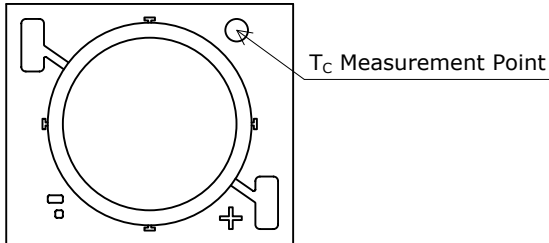

- $R_{\theta JC}$ may change depending on the properties for both the dissipating material used (e.g. film, gel sheet, paste, or glue) and the heat sink/housing and the surface state of those materials. When mounting the LEDs on to the heat sink/housing, the following must be considered:

- Heat dissipating materials with a low thermal resistance should be used for the interface between the LED and heat sink/housing.
- The surface of the heat sink used with the LEDs must not have any small recesses, cavities or holes; if necessary, the surface must be leveled before mounting the LEDs.
- If a holder and/or heat dissipating material are used, ensure that these materials are properly used and the heat is effectively dissipated.

During use if the heat dissipating material deteriorates due to heat and the dimensions change and/or the properties degrade, it may cause these materials not to dissipate the heat properly; this may cause the LED to be damaged.

Ensure that reliability verification is performed for the chosen application.

- To determine the temperature of the LEDs, a non-contact temperature measurement instrument (e.g. thermal imaging camera) is useful. These measurement results may be able to be used for the heat dissipation design of the chosen application.
- Refer to the relevant application notes for detailed information (e.g. how to handle the COB LEDs, the effect of adhesion strength between the COB and the housing, thermal design considerations, etc.).**
To access the application notes, go to the Technical Suggestions And Recommendations section of Nichia's website.

(7) Cleaning

- The LEDs should not be cleaned with water, benzine, and/or thinner.
- If required, isopropyl alcohol (IPA) should be used. Other solvents may cause premature failure to the LEDs due to the damage to the resin portion. The effects of such solvents should be verified prior to use.
In addition, the use of CFCs such as Freon is heavily regulated.
- When dust and/or dirt adheres to the LEDs, soak a cloth with Isopropyl alcohol (IPA), then squeeze it before wiping the LEDs.
- Ultrasonic cleaning is not recommended since it may have adverse effects on the LEDs depending on the ultrasonic power and how LED is assembled.
If ultrasonic cleaning must be used, the customer is advised to make sure the LEDs will not be damaged prior to cleaning.

(8) Eye Safety

- In 2006, the International Electrical Commission (IEC) published IEC 62471:2006 Photobiological safety of lamps and lamp systems, which added LEDs in its scope.
On the other hand, the IEC 60825-1:2007 laser safety standard removed LEDs from its scope.
However, please be advised that some countries and regions have adopted standards based on the IEC laser safety standard IEC 60825-1:20112001, which still includes LEDs in its scope.
Most of Nichia's LEDs can be classified as belonging into either the Exempt Group or Risk Group 1.
High-power LEDs, that emit light containing blue wavelengths, may be classified as Risk Group 2.
Please proceed with caution when viewing directly any LEDs driven at high current, or viewing LEDs with optical instruments which may greatly increase the damages to your eyes.
- Viewing a flashing light may cause eye discomfort. When incorporating the LED into your product, please be careful to avoid adverse effects on the human body caused by light stimulation.

(9) Miscellaneous

- Nichia warrants that the discrete LEDs will meet the requirements/criteria as detailed in the Reliability section within this specification. If the LEDs are used under conditions/environments deviating from or inconsistent with those described in this specification, the resulting damage and/or injuries will not be covered by this warranty.
- Nichia warrants that the discrete LEDs manufactured and/or supplied by Nichia will meet the requirements/criteria as detailed in the Reliability section within this specification; it is the customer's responsibility to perform sufficient verification prior to use to ensure that the lifetime and other quality characteristics required for the intended use are met.
- The applicable warranty period is one year from the date that the LED is delivered. In the case of any incident that appears to be in breach of this warranty, the local Nichia sales representative should be notified to discuss instructions on how to proceed while ensuring that the LED in question is not disassembled or removed from the PCB if it has been attached to the PCB. If a breach of this warranty is proved, Nichia will provide the replacement for the non-conforming LED or an equivalent item at Nichia's discretion. FOREGOING ARE THE EXCLUSIVE REMEDIES AVAILABLE TO THE CUSTOMER IN RESPECT OF THE BREACH OF THE WARRANTY CONTAINED HEREIN, AND IN NO EVENT SHALL NICHIA BE RESPONSIBLE FOR ANY INDIRECT, INCIDENTAL OR CONSEQUENTIAL LOSSES AND/OR EXPENSES (INCLUDING LOSS OF PROFIT) THAT MAY BE SUFFERED BY THE CUSTOMER ARISING OUT OF A BREACH OF THE WARRANTY.
- NICHIA DISCLAIMS ALL OTHER WARRANTIES, EXPRESS OR IMPLIED, INCLUDING THE IMPLIED WARRANTIES OF MERCHANTABILITY AND FITNESS FOR A PARTICULAR PURPOSE.
- This LED is intended to be used for general lighting, household appliances, electronic devices (e.g. mobile communication devices); it is not designed or manufactured for use in applications that require safety critical functions (e.g. aircraft, automobiles, combustion equipment, life support systems, nuclear reactor control system, safety devices, spacecraft, submarine repeaters, traffic control equipment, trains, vessels, etc.). If the LEDs are planned to be used for these applications, unless otherwise detailed in the specification, Nichia will neither guarantee that the LED is fit for that purpose nor be responsible for any resulting property damage, injuries and/or loss of life/health.
This LED does not comply with ISO/TS 16949 and is not intended for automotive applications.
- The customer will not reverse engineer, disassemble or otherwise attempt to extract knowledge/design information from the LED.
- All copyrights and other intellectual property rights in this specification in any form are reserved by Nichia or the right holders who have granted Nichia permission to use the content. Without prior written permission from Nichia, no part of this specification may be reproduced in any form or by any means.
- Both the customer and Nichia will agree on the official specifications for the supplied LEDs before any programs are officially launched. Without this agreement in writing (i.e. Customer Specific Specification), changes to the content of this specification may occur without notice (e.g. changes to the foregoing specifications and appearance, discontinuation of the LEDs, etc.).