

MOON

design

Jose I. Ballester



El diseñador José Ignacio Ballester combinando y jugando con formas circulares, junto perforados ovaes que nos recuerdan, de forma simple, a la Luna, crea para Mantra..MOON. La superposición armoniosa de distintas capas acrílicas rematadas con sencillos calados de distintos tamaños, hacen de Moon una simpática colección de iluminación que por sí misma crea ambiente a la vez que decora. Sus materiales acrílicos (antiadherentes) se combinan con brillantes cromos, generando una extensa propuesta de lámparas y piezas auxiliares, que de forma discreta albergan la eficaz luz de bajo consumo (potencia 13w.) homologada y testada bajo la normativa CE. Esta simple explicación se ve corroborada, con lo que a continuación van a poder apreciar en estas páginas. Para uds...MOON.

The designer, José Ignacio Ballester, combines and plays with circular shapes, jointly with perforated oval forms, whose simple design reminds us of the Moon, specially created for Mantra... MOON. The harmonious overlap of different acrylic layers finished with simple depths of various sizes characterize the Moon collection's lovely lighting design which simultaneously creates and decorates the atmosphere. Its (non-stick) acrylic materials are combined with shiny chrome finishes to create an extensive range of lamps and accessory parts, which discretely house efficient low-consumption light (13W power), officially approved and tested according to EC legislation. This simple explanation will be verified with the information provided in the following pages. For you, ...the MOON.











1351 - Colgante/Pendant

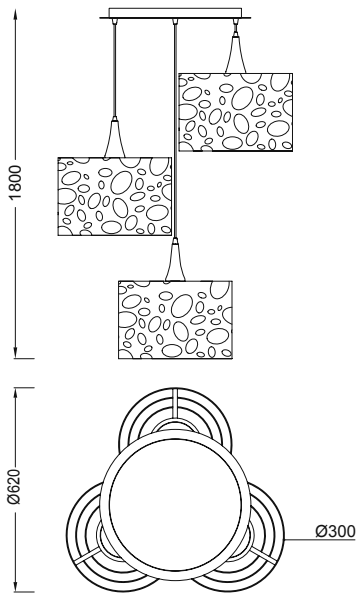

- E27 3x20W - 220/240V (no incl.)
- Polímero Negro - Black Polymer
- Polímero Blanco - White Polymer
- Cromo - Chrome

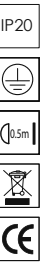

1361 - Colgante/Pendant

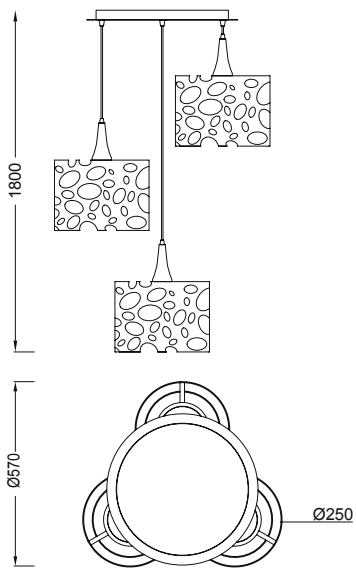

- E27 3x20W - 220/240V (no incl.)
- Polímero Blanco - White Polymer
- Cromo - Chrome



1366 [Blanco/White] - Aplique/Wall Lamp

1370 [Negro/Black] - Aplique/Wall Lamp

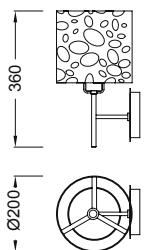

- E27 1x20W - 220/240V (no incl.)
- Polímero Negro - Black Polymer
- Polímero Blanco - White Polymer
- Cromo - Chrome



1350 - Colgante/Pendant

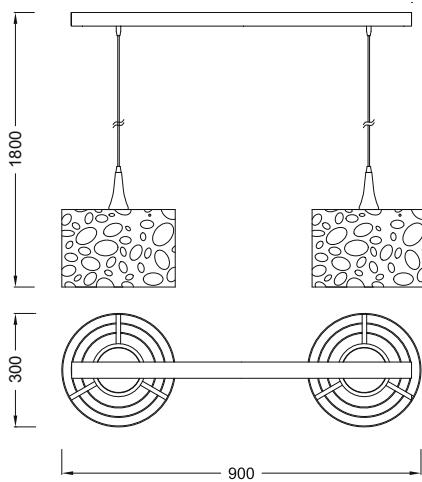

E27 2x20W - 220/240V (no incl.)

Polímero Negro - Black Polymer

Polímero Blanco - White Polymer

Cromo - Chrome



1360 - Colgante/Pendant

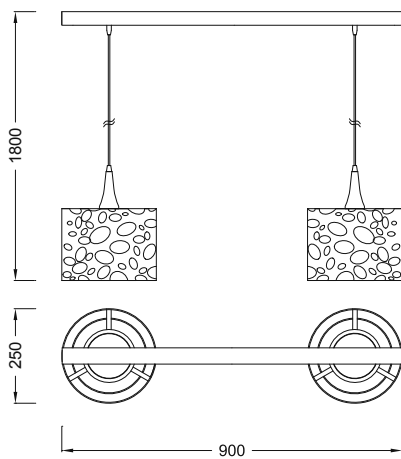

E27 2x20W - 220/240V (no incl.)

Polímero Blanco - White Polymer

Cromo - Chrome

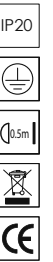

1352 - Colgante/Pendant

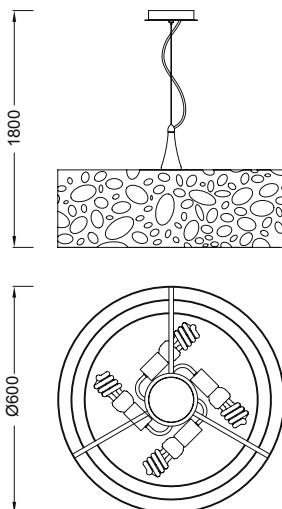

E27 4x20W - 220/240V (no incl.)

Polímero Negro - Black Polymer



Polímero Blanco - White Polymer

Cromo - Chrome

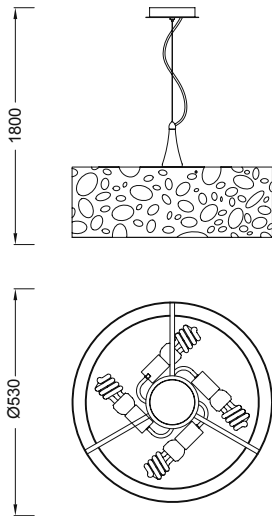

1362 - Colgante/Pendant Lamp







-  E27 4x20W - 220/240V (no incl.)
-  Polímero Blanco - White Polymer
-  Cromo - Chrome

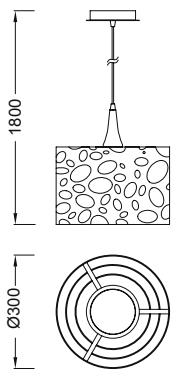

1353 - Colgante/Pendant Lamp





-  E27 1x20W - 220/240V (no incl.)
-  Polímero Negro - Black Polymer
-  Polímero Blanco - White Polymer
-  Cromo - Chrome

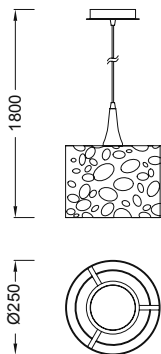

1363 - Colgante/Pendant Lamp



-  E27 1x20W - 220/240V (no incl.)
-  Polímero Blanco - White Polymer
-  Cromo - Chrome



1356 - Sobremesa/Table Lamp

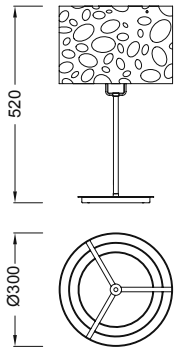

- E27 1x20W - 220/240V (no incl.)
- Polímero Negro - Black Polymer
- Polímero Blanco - White Polymer
- Cromo - Chrome



1367 - Sobremesa/Table Lamp

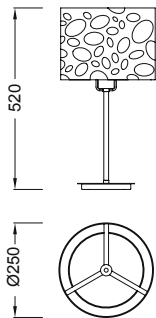

- E27 1x20W - 220/240V (no incl.)
- Polímero Blanco - White Polymer
- Cromo - Chrome



1357-1368 - Pie de Salón/Floor Lamp

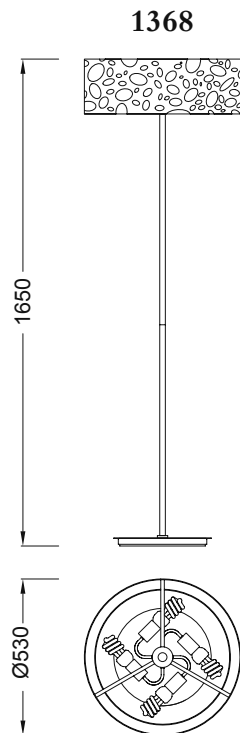
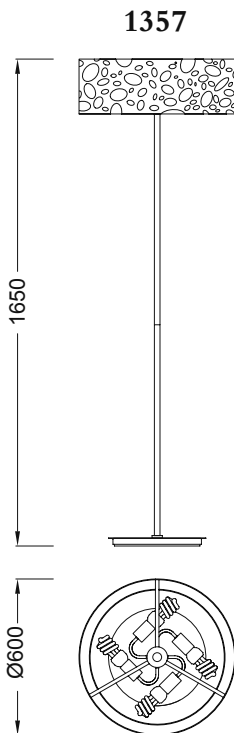

- 1357**
- E27 4x20W - 220/240V (no incl.)
 - Polímero Negro - Black Polymer
 - Polímero Blanco - White Polymer
 - Cromo - Chrome



- 1368**
- E27 4x20W - 220/240V (no incl.)
 - Polímero Blanco - White Polymer
 - Cromo - Chrome

